

Sears

OWNERS MANUAL

MODEL NOS.

625.340400
CAPACITY 40

625.340500
HIGH CAPACITY 50

625.340700
EXTRA
HIGH CAPACITY 70

CAUTION

Read All Safety
Guides Before
You Start to
Install Your
Softener

AVOID UNNEEDED SERVICE CALLS...

Read the HELPFUL
HINTS CHECKLIST on
page 25. The program-
ming guides on the
underside of the salt
storage tank cover are
also helpful.

SAVE THIS MANUAL



Kenmore WATER SOFTENERS

- HOW TO INSTALL —
- HOW IT WORKS —
- CARE OF —
- SPECIFICATIONS —
- REPAIR PARTS —

Sears, Roebuck and Co., Chicago, Ill. 60684 U.S.A.

TABLE OF CONTENTS

	PAGE NO.		PAGE NO.
Safety Guides	3	Setting the Timer	14
Before You Install	3-5	How Your Softener Works	15-17
Tools and Materials Needed	4	"Fine-Tuning" Your Softener	18-22
Plans to Install Your Softener	5-8	Care of Your Softener	23-25
Sweat Soldering Tips	7	Dimensions and Specifications	26
Step by Step Guides to Install Softener ..	9-14	Repair Parts	27-31

WARRANTY

SEARS RESIDENTIAL AUTOMATIC WATER SOFTENER

FULL ONE YEAR WARRANTY ON WATER SOFTENER

For one year from the date of purchase, when this water softener is installed and maintained in accordance with our instructions, Sears will repair, free of charge, defects in material or workmanship in this water softener.

FULL TEN YEAR WARRANTY AGAINST LEAKS

For ten years from the date of purchase, Sears will furnish and install a new current model water softener tank or salt storage drum, free of charge, if either the tank or drum develop a leak.

TO OBTAIN WARRANTY SERVICE, SIMPLY CONTACT THE NEAREST SEARS SERVICE CENTER THROUGHOUT THE UNITED STATES. THIS WARRANTY APPLIES ONLY WHILE THIS PRODUCT IS IN USE IN THE UNITED STATES.

This warranty gives you specific legal rights, and you may have other rights which vary from state to state.

Sears, Roebuck and Co., Dept. 698/731A, Sears Tower, Chicago, IL 60684

If you want your water softener professionally installed, talk to your Sears Salesperson who will arrange a prompt, quality installation by Sears Authorized Installers.

SEARS INSTALLATION POLICY

All installation labor arranged by Sears shall be performed in a neat, workmanlike manner in accordance with generally accepted trade practices. Further, all installations shall comply with all local laws, codes, regulations and ordinances. Customer shall also be protected, during installation, by insurance relating to Property Damage, Workman's Compensation and Public Liability.

SEARS INSTALLATION WARRANTY

In addition to any warranty extended to you on the Sears merchandise involved, which warranty becomes effective the date the merchandise is installed, should the workmanship of any Sears arranged installation prove faulty within one year, Sears will, upon notice from you, cause such faults to be corrected at no additional cost to you.

GUIDES TO SAFELY INSTALL AND USE YOUR SOFTENER

▲ **Read all steps, guides and rules carefully before installing and using your new water softener. Follow all steps exactly to correctly install. Failure to follow them could cause personal injury or property damage. Reading this book will also help you to get all of the benefits from your water softener.**

▲ **Your water softener will remove hardness minerals and “clear water” iron from water, up to the limits shown on page 26. It will not remove other types of iron, acids, tastes and odors, etc. It will not purify polluted water or make it safe to drink.**

When you see this sign in the book, ▲ something could be damaged, or someone hurt, if the guide is not followed exactly.

▲ **Check with your local public works department for plumbing, electric and sanitation codes. You must follow their guides as you install your softener.**

▲ **Protect the softener and piping from freezing. Damage from freezing voids the softener warranty.**

▲ **Be sure the electric outlet for the softener is grounded the right way to protect the user from injury or possibly fatal shock.**

▲ **THIS SOFTENER WORKS ON 24 VOLTS ONLY. BE SURE TO USE THE TRANSFORMER INCLUDED, AND PLUG IT INTO A 120V OUTLET.**

BEFORE YOU START TO INSTALL YOUR SOFTENER

HELPFUL INFORMATION

If you know little about plumbing skills, we suggest you get a book on the subject. There are many good books for do-it-yourselfers on the basics of plumbing. You can get a low cost book from Sears Plumbing and Heating departments that will help you. Some basic sweat soldering tips are on page 7 of this manual.

WATER SYSTEM TESTS

HAS YOUR WATER SUPPLY HAD A CHEMICAL ANALYSIS? Sears has many kinds of water treating units (see page 4) to correct different water problems. To know the kind and size of unit you need, you must first know what elements are in your house water supply. A chemical analysis shows the type and amounts of elements in water. If your water needs analysis, call or write your nearest Sears store for help.

CHECK YOUR WATER PRESSURE — For your softener to work right, a water pressure of no lower than 20 pounds per square inch (psi) is needed in the house water pipes. The highest pressure allowed in the water pipes is 120 psi. If pressure is over 120 psi, buy and install a pressure reducing valve in the water inlet pipe to the softener. **NOTE:** If water pressure during the day is 100 psi or more, pressure during the night may go over 120 psi.

If you have a well water system, look at the pressure gauge to find the water pressure. Call your local water department if you have city water. They will tell you what the water pressure is where you live.

CHECK YOUR WATER FLOW RATE - A water flow of at least 3 gallons per minute is needed. A lower flow will keep your softener from working as well as it should. To make an easy check of your flow rate, do the following. You will need a 1 gallon container (can, jar, pail, etc.).

1. Fully open 2 cold water faucets close to the point water enters the house.
2. With both faucets open, fill the gallon container at 1 faucet while looking at a watch or clock to see how many seconds it takes.
3. Empty the container and go the second faucet (be sure BOTH faucets are still on). Fill the gallon container at the second faucet and see how many seconds it takes.
4. Turn off both faucets. Now add the number of seconds it took to fill the container at both faucets.
5. A total of 90 seconds, or less, means the system flow rate is good.

BEFORE YOU START TO INSTALL YOUR SOFTENER

FACTS AND FIGURES TO KEEP

Fill in the blanks below and keep this book in a safe place so you always have these facts.

Water Softener Model No. † _____

Serial Number _____

Date Installed _____

Water Hardness _____ Grains Per Gallon

Iron Content _____ Parts Per Million

*pH _____ Taste And/Or Odor _____

Water Pressure _____ Pounds/Square Inch

Water Flow Rate _____ Gallons Per Minute

†Get from the rating decal on the softener.

*The acidity or alkalinity measure of water

WHERE TO PUT THE SOFTENER

Think of the following points as you choose a place to put your softener. (See Fig. 1).

- Place as close as possible to the pressure tank (well water) or water meter (city water).
- Place as close as possible to a water drain such as a floor drain, laundry tub, sump or standpipe.
- ▲ • Connect to the house main water pipe BEFORE THE WATER HEATER. Temperature of water going through the softener must not be more than 120 F (49 C).

- Keep your outside faucets on hard water to save soft water and salt.
- ▲ • DO NOT install in a place where the softener could freeze. Freeze damage voids the warranty by Sears, Roebuck and Co. (See page 24.)
- ▲ • A 120V electric outlet, to plug the transformer into, is needed within 10 feet of the softener (the softener has a 10 foot power cable). Be sure the outlet and transformer are in an inside place, to protect from wet weather.
- ▲ • Keep the softener out of direct sunlight. The sun's heat can melt plastic parts.
- ▲ • Put the softener in a place water damage is least likely to occur if it develops a leak. Sears or the manufacturer will not repair or pay for water damage.

TOOLS, PIPE, FITTINGS AND OTHER MATERIALS YOU WILL NEED

To know what tools and materials you will need, you must first decide how to run in and out pipes to the softener. Look at your house main water pipe at the point you will connect the softener. Is the pipe soldered copper, glued plastic, or threaded galvanized or brass? What is the pipe size?

Now look at the common plans for in and out piping on pages 6 and 8. Select the drawing best for you and use it as a guide to plan what materials you will need. As you plan your in and out piping, keep in mind the following check list. Then get all the materials you will need.

FIG. 1 THE PROPER ORDER TO INSTALL WATER TREATING EQUIPMENT

(Shows sequence of equipment only — seldom, if ever, would all items be needed)

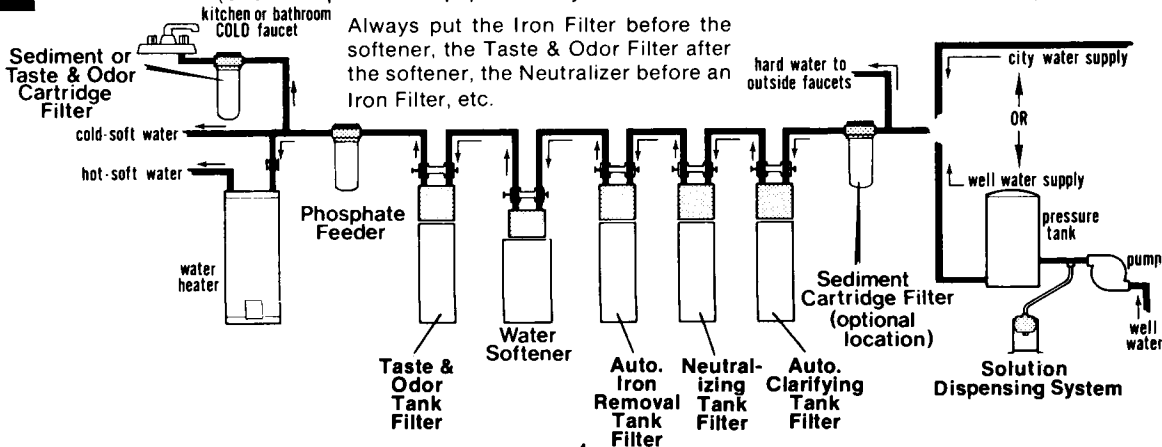

BEFORE YOU START TO INSTALL YOUR SOFTENER

CONTINUED FROM PAGE 4

- ✓ In and out pipes to the softener must be at least 3/4 in. size. Some local codes may tell you to use no less than 1 in. pipe size.
- ✓ Use copper, brass, or galvanized pipe and fittings. Some codes may also allow CPVC plastic pipe.
- ✓ Copper and galvanized pipe corrode fast when connected together.
- ✓ You can buy adaptors to go from a copper or threaded main water pipe to CPVC in and out pipe.
- ✓ Sears has kits and bypass valves you can buy to help make installing your softener easier.
- ✓ ALWAYS install a bypass valve or valves. Either use 3 shut-off valves, or 1 of Sears special valves. Bypass valves let you turn off water to the softener, but still have water in the house pipes.
- ✓ Drain hose (7/16 in. inside diameter) is needed for valve and salt tank drains. See steps 9 and 10 on page 11. You can buy flexible hose at most Sears stores or through Sears catalog.

If a rigid valve drain is needed to comply with plumbing codes, Sears has a copper drain kit (See page 11) to change the softener to a 1/2 in. copper tubing drain.

DRAW THE PLANS FOR YOUR IN AND OUT PIPING HERE. BE SURE TO FOLLOW GUIDES LISTED ABOVE. INCLUDE ALL PIPE, FITTINGS AND ACCESSORIES YOU WILL USE. MAKE A LIST OF ALL MATERIALS YOU NEED AND BUY THEM BEFORE YOU BEGIN TO INSTALL THE SOFTENER.

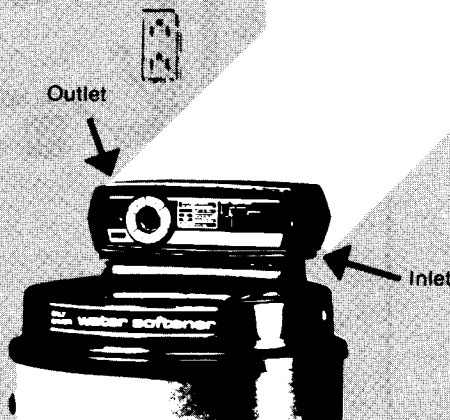

- ✓ For electric hook-up you may need a length of copper wire (See page 13).

- ✓ TOOLS NEEDED: - common and cross point (Phillips) screw drivers, slip-joint pliers and a tape measure or rule. ALSO . . .

. . . for SOLDERED COPPER - tubing cutter, propane torch, solid-core solder, paste flux, emery cloth, sandpaper or steel wool.

. . . for THREADED PIPE - hacksaw or pipe cutter, pipe wrenches, pipe threading tool, pipe joint compound.

. . . for CPVC PLASTIC - hacksaw, adjustable wrench, solvent cement, fine emery cloth.

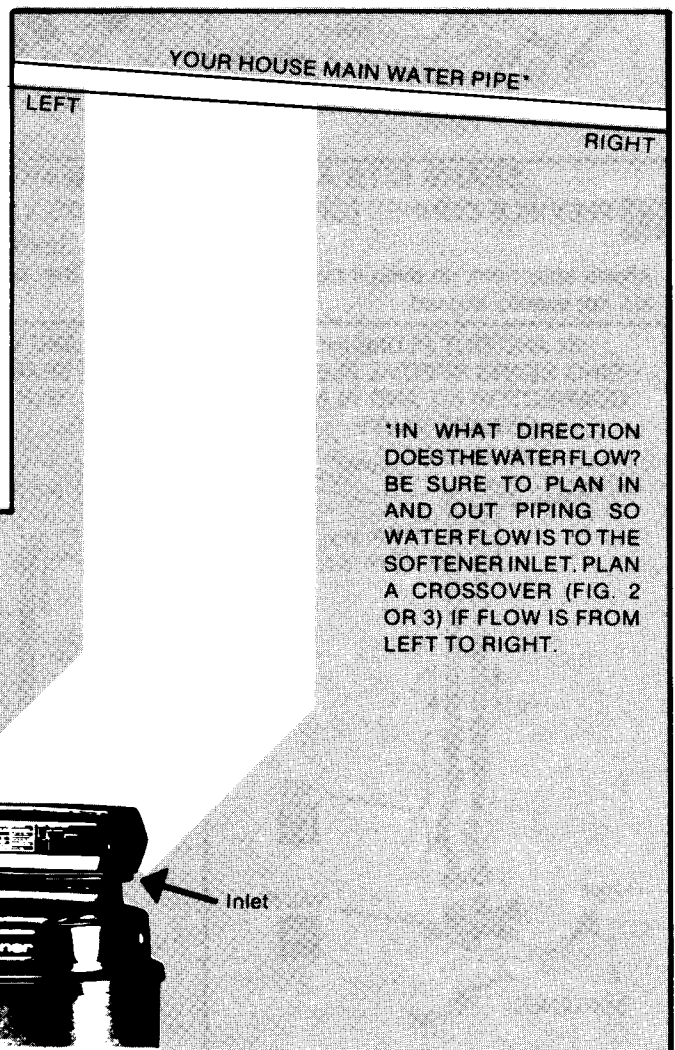

COMMON PLANS FOR IN AND OUT PIPES TO SOFTENER

FIG. 2 SOLDERED COPPER (or CPVC)

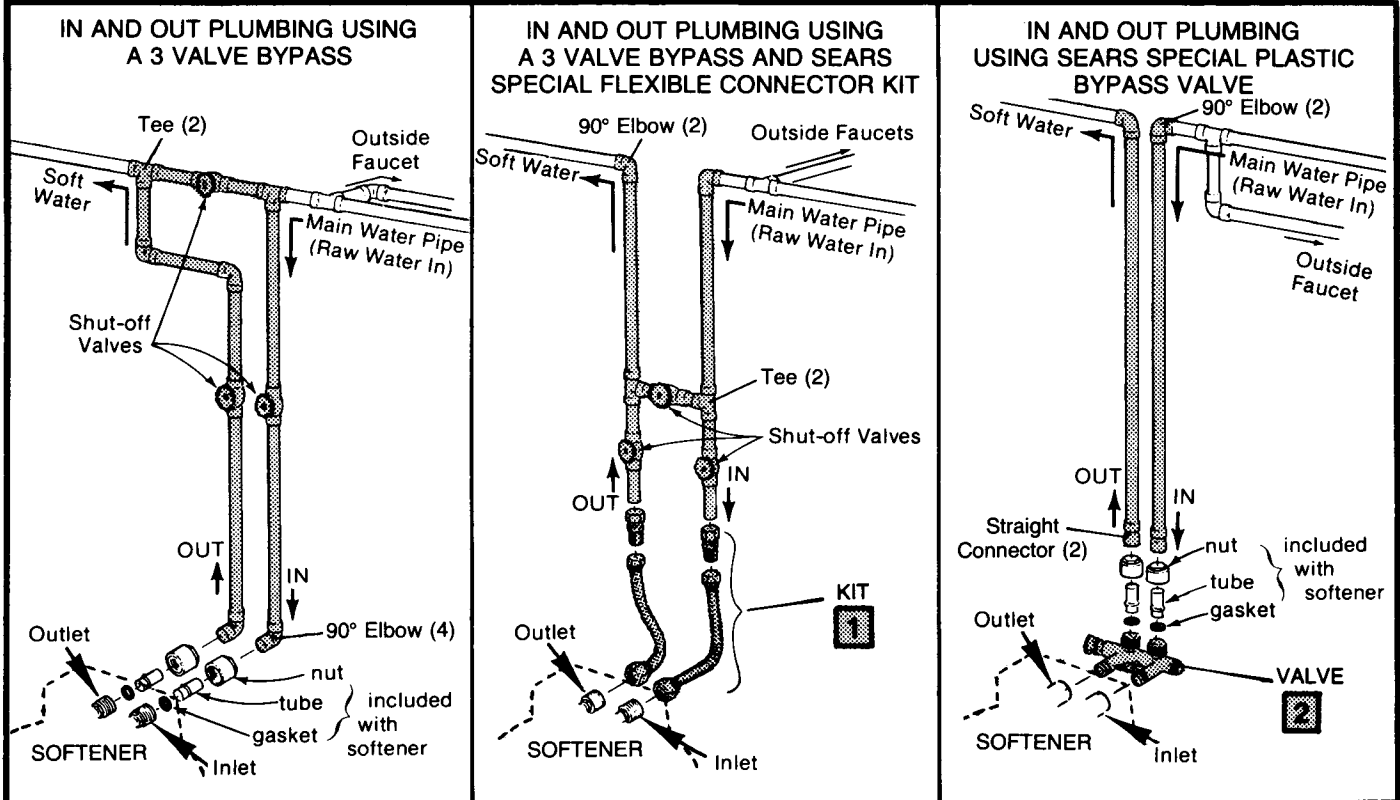

SEARS KITS AND VALVES TO MAKE INSTALLING YOUR SOFTENER EASIER

1 FLEXIBLE CONNECTORS

Allows easy hook up even if pipes are not exactly aligned.

2 BYPASS VALVE (Plastic)

Sears Stock No. 42-3437

One, easy working valve takes the place of 3 separate valves.

3 BYPASS VALVE (Brass)

Sears Stock No. 42-3436

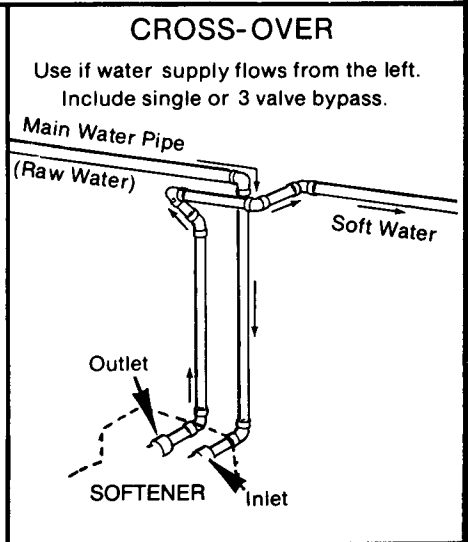
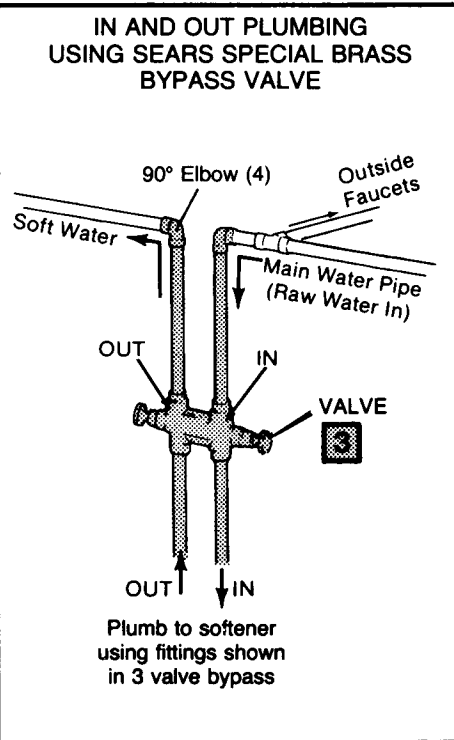
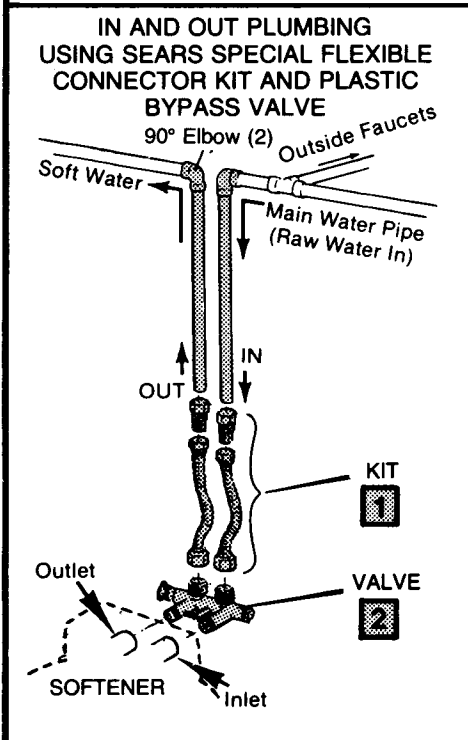

SWEAT SOLDERING TIPS

- **MEASURING PIPE LENGTHS:** Always be sure to include the length of pipe that goes inside the fitting. On 3/4 in. pipe, this length is about 3/4 in.

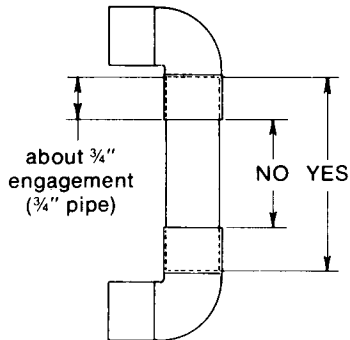

CUTTING PIPE: Turn the pipe cutter back and forth around the outside of the pipe. Tighten the pipe cutter slowly with each turn until all the way through the pipe. To keep from crushing or distorting the pipe, do not tighten the cutter too much at a time. File burrs from cut ends.

CLEAN PIPE AND FITTING SOLDERING SURFACES: With emery cloth, fine sandpaper or steel wool, clean the end of the pipe and inside of the fitting. Clean surfaces until they shine. Do not grind off too much material, making the fit too loose.

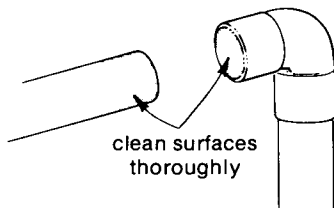

CHECK THE FIT: Push the pipe into the fitting as far as it will go. Use some force to slip together, but do not hammer or pound. If too tight, clean surfaces until fit is good.

PUT ON PASTE FLUX: Freely apply paste flux on both cleaned surfaces. Place pipe into the fitting and turn to spread the paste around.

BEFORE SOLDERING, READ THESE SAFETY GUIDES.

- ▲ Keep torch flame away from walls, the water softener, and other materials that will burn.
- ▲ Do not touch newly soldered pipe with your hands.

Wrap nearby, already soldered joints with a wet cloth so solder does not melt.

Let soldered joints cool slowly. Sudden cooling can crack or weaken the solder.

SOLDERING: Light the torch and set to a moderate flame. Move the flame over and around the joint to heat pipe and fitting. In a short time, touch the end of the solder wire to the lip of the fitting. **DO NOT PLACE SOLDER IN THE FLAME.** The solder will melt and draw into the connection when the pipe and fitting are at the right temperature. Run the solder around the lip until the joint is full. Do not overfill as solder will run into and harden inside the fitting. Being careful not to touch the pipe with your hands, make a quick swipe around the joint with a cloth to take off excess solder.

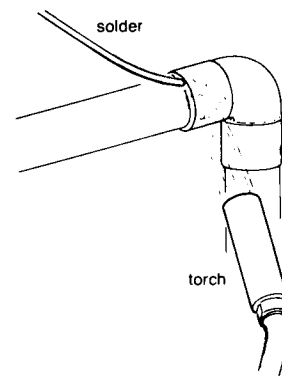

For a good sweat solder joint, the pipe and fitting must not have any water inside them. Water, when heated by the torch, weakens the solder and often the joint will leak. If you can not keep the inside of the pipe dry, wad up a piece of bread into a ball. After putting paste flux on both the pipe and fitting, place the bread wad into the pipe and poke in several inches. Put the pipe and fitting together and solder. The bread absorbs moisture while you are soldering. When the water is turned on, the bread dissolves and is flushed out an open faucet.

LEAKING CONNECTIONS: You can try to reheat and resolder a leaking joint, but it's usually best to start over. Turn off the water, reheat and take the pipe and fitting apart. Take off all old solder, cleaning down to the copper surface. Apply new paste flux and solder again.

COMMON PLANS FOR IN AND OUT PIPES TO SOFTENER

FIG. 3 **THREADED PIPE — GALVANIZED OR BRASS**

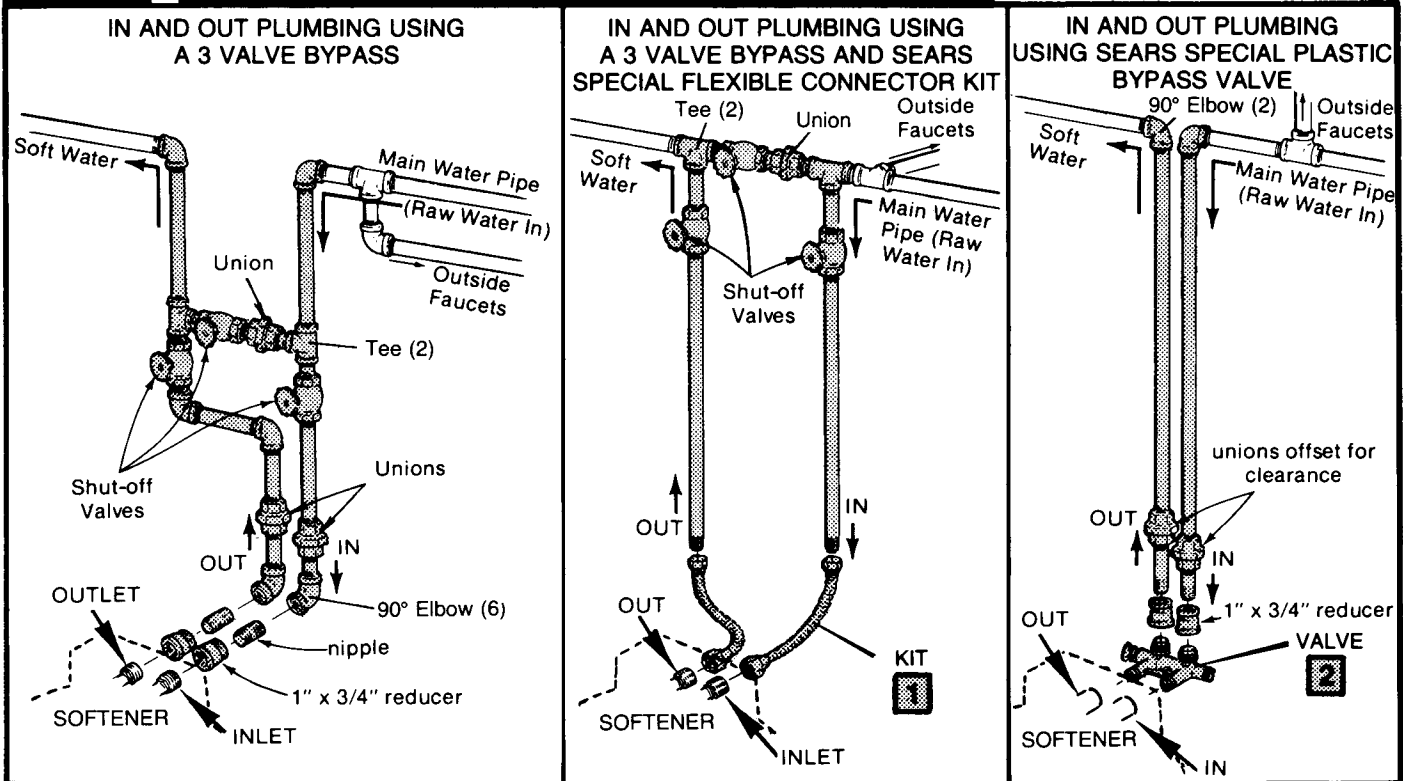

SEARS KITS AND VALVES TO MAKE INSTALLING YOUR SOFTENER EASIER

1 FLEXIBLE CONNECTORS

Allows easy hook up, even if pipes are not exactly aligned.

2 BYPASS VALVE

Sears Stock No. 42-3437

One, easy working valve takes the place of 3 separate valves.

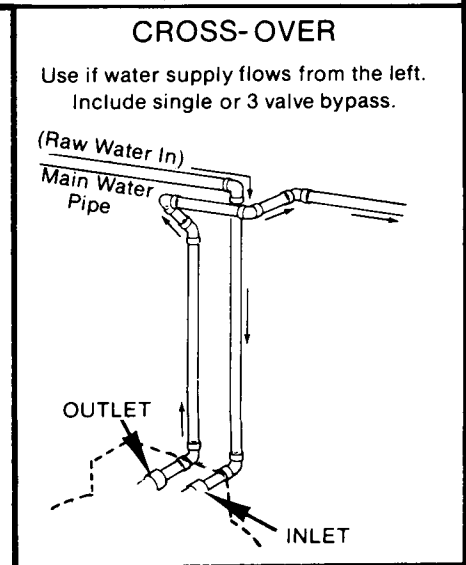
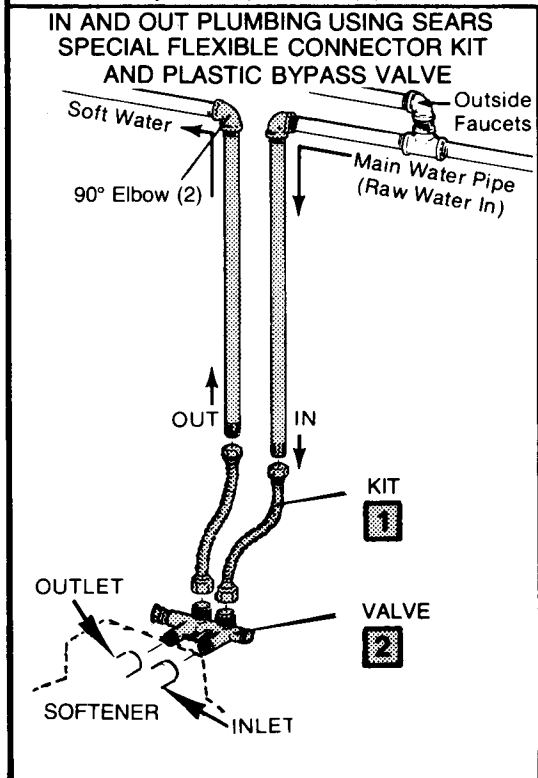

STEP BY STEP GUIDES TO INSTALL YOUR SOFTENER

- ▲1. Close the shut-off valve on the house main water pipe, near the water meter or pressure tank, to turn off the water.
- ▲2. Shut off the gas or electric supply to the water heater.
- ▲3. Open the highest and lowest water faucets in your house to let water drain from the pipes. Close faucets after water has drained.

4. If not already done, remove all cardboard or plastic packing pieces from inside the softener. Take the bag with small parts. Remove parts and lay out neatly so you can find them when needed.

5. INSTALL THE INLET SCREEN, AND THE INLET AND OUTLET ADAPTORS OR SEARS BYPASS VALVE, STOCK NO. 42-3437.

a. **INLET SCREEN** - The inlet screen (Fig. 4 or 5) is with the small parts bag items. This screen, put in the softener valve inlet, stops dirt and other sediments from getting inside the softener. To install it, put it into the valve inlet with the pointed end facing outward, toward incoming water.

b. **INLET AND OUTLET ADAPTORS** (Do not use if you will install the bypass valve) - Push the adaptors into the valve inlet and outlet ports (Fig. 4) as far as they will go. Both adaptors are the same and fit either valve port. SNAP THE 2 LARGE HOLDING CLIPS INTO PLACE, FROM THE TOP DOWN AS SHOWN. BE SURE THEY SNAP FIRMLY INTO PLACE SO THE ADAPTORS CAN NOT PULL OUT.

IF YOU DO NOT USE SEARS BYPASS VALVE, STOCK NO. 42-3437, DO STEP 6. IF YOU DID INSTALL THIS BYPASS VALVE, SKIP STEP 6 AND GO TO STEP 7.

FIG. 4 INSTALLING INLET SCREEN, AND THE INLET AND OUTLET ADAPTORS

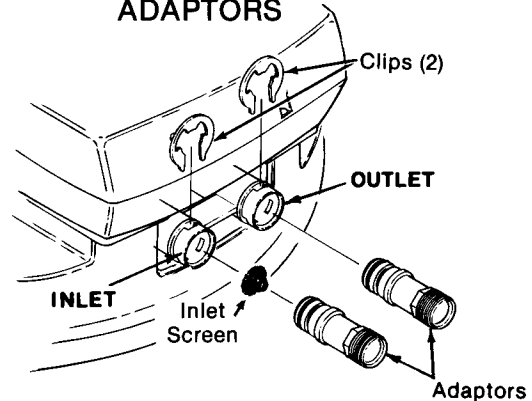

FIG. 5 INSTALLING INLET SCREEN AND BYPASS VALVE

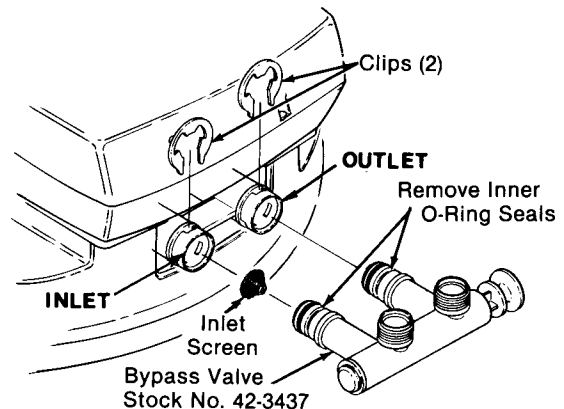
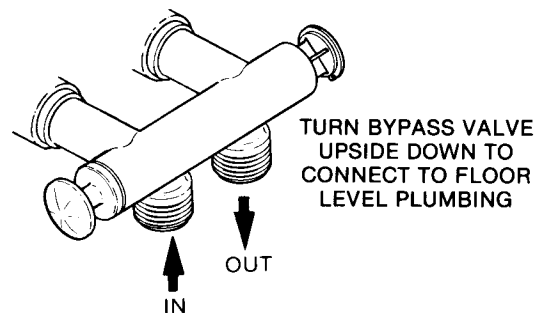

FIG. 6 BYPASS VALVE TURNED DOWNWARD



c. **BYPASS VALVE, STOCK NO. 42-3437** - If the bypass valve has 4 o-ring seals on it, remove the inner one on both sides (Fig. 5). Push the bypass valve into the softener valve as far as it will go (Fig. 5 or 6). SNAP THE 2 LARGE HOLDING CLIPS INTO PLACE, FROM THE TOP DOWN AS SHOWN. BE SURE THEY SNAP FIRMLY IN PLACE SO THE BYPASS VALVE CAN NOT PULL OUT.

STEP BY STEP GUIDES TO INSTALL YOUR SOFTENER

6. INSTALLING 3 VALVE BYPASS, OR SEARS BYPASS VALVE, STOCK NO. 42-3436, AND PIPES (FIG. 7)

Cut the house main water pipe where you will connect the softener. Loosely put together pipe, fittings, and the 3 valves or Sears special bypass valve. Place valve(s) within easy reach. Look at your plan drawing on page 5.

IMPORTANT: WHEN LOOKING AT THE FRONT OF THE SOFTENER, THE INLET IS ON THE RIGHT SIDE. IF WATER IN YOUR HOUSE MAIN WATER PIPE RUNS FROM LEFT TO RIGHT, BE SURE TO USE A "CROSS-OVER" AS SHOWN IN FIG. 2 AND 3.

If all pipe, fittings and valves fit together good, tighten all threaded joints (use pipe dope on outside threads), or solder following tips on page 7.

7. MOVE SOFTENER INTO PLACE

Move the softener into place. Be sure the surface it sets on is level and smooth. If needed, put a piece of 3/4" plywood, at least 18" square, under the tank. Then put a spacer under the plywood to level the softener.

8. CONNECT THE SOFTENER — SOLDER COPPER OR CPVC PIPE

(Refer to your plan drawing on page 5, and to page 6.)

- Read the important note above. Then put the gaskets, tubes and nuts shown in FIG. 8, or the flexible connectors (Sears kit), onto the softener or bypass valve.
- Measure, cut and put all pipe and fittings together up to the main water pipe, or to the bypass valve (s) you installed in step 6 above.
- When all piping fits together good, solder (or glue CPVC) all joints following tips on page 7.

▲ **CAUTION:** BEFORE SOLDERING, DISCONNECT NUTS (FIG. 8) AT THE SOFTENER OR BYPASS VALVE. THIS WILL STOP THE HEAT, CAUSED BY THE SOLDERING, FROM GOING INTO THE SOFTENER VALVE AND MELTING PLASTIC PARTS. After plumbing cools, put nuts back on and tighten.

FIG. 7 BYPASS VALVES

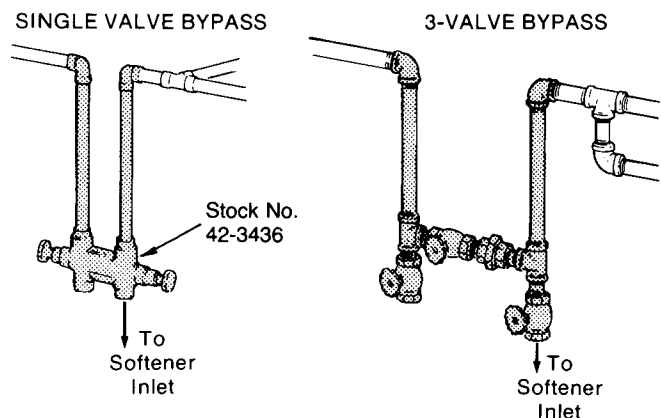
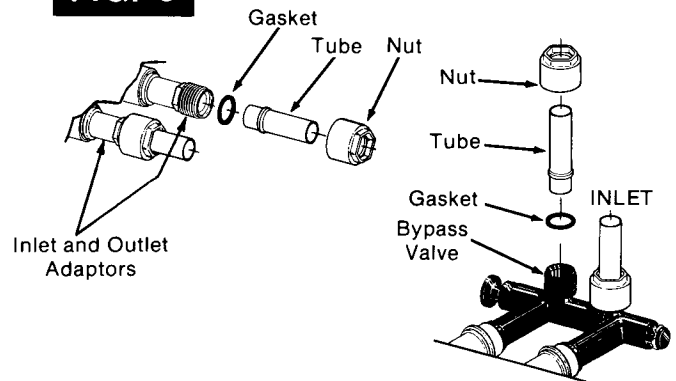

FIG. 8 INLET-OUTLET FITTINGS



8. CONNECT THE SOFTENER — THREADED PIPE.

(Refer to your plan drawing on page 5, and to page 8)

- Read the important note above, left. Then measure, cut, thread and put together pipe and fittings from the softener (or bypass valve) up to the main water pipe, or to the bypass valves installed in step 6.
- Include union fittings or flexible connectors (Sears kit).
- Cut pipe lengths exact for correct aligning, and to prevent putting weight on the valve. Use pipe dope or teflon tape on all outside threads.

▲ **CAUTION:** BE VERY CAREFUL WHEN PUTTING PIPE FITTINGS ONTO THE PLASTIC THREADS OF THE SOFTENER ADAPTORS OR THE BYPASS VALVE. DO NOT CROSS-THREAD. DO NOT OVERTIGHTEN.

STEP BY STEP GUIDES TO INSTALL YOUR SOFTENER

9. CONNECT THE VALVE DRAIN HOSE

Take a length of 7/16" inside diameter (I.D.) drain hose and attach 1 end to the flow washer housing (FIG. 9). Use a hose clamp to hold it in place. Put the other end of the hose over a floor drain, or into a laundry tub (FIG. 9), into a sump or standpipe (FIG. 10), or into some other suitable drain. CHECK YOUR LOCAL CODES.

IMPORTANT NOTES: [See Fig. 9, 10 and 11]

▲ Leave an air gap of about 1-1/2" between the end of the hose and the drain. This gap is needed so you don't get a back-flow of sewer water into the softener. DO NOT put the end of the hose into the drain or connect without the air gap.

▲ Place and support the hose so it does not kink or have sharp bends. Tie or wire the hose in place so water pressure will not make it "whip". Do not pinch the hose shut.

▲ Keep the hose lower than the flow washer housing. (In some homes, to get to a drain you must raise the hose and run it over-head. If you need an over-head drain, do not raise the hose more than 8' above the floor. A copper drain line is best to use...see below.)

COPPER DRAIN KIT: The plumbing codes where you live may say that you must use a copper valve drain line. A copper line is also best to use for an over-head drain. Use a copper drain line if the softener is installed outside, or in the sunlight. Heat from the sun makes many kinds of rubber or plastic hose to collapse or close up.

You can get the kit shown in Fig. 11 from Sears. It is put in place of the flow washer housing that comes with the softener. How to install guides are in the kit.

10. CONNECT A SALT TANK OVERFLOW HOSE

a. Take the rubber grommet, hose adaptor and hose clamp (Fig. 9) that were in the small parts bag.

b. Push the grommet into the hole in the salt tank wall so half is inside and half is outside.

c. Push the bigger end of the hose adaptor into the grommet.

d. Push one end of a length of 7/16" I.D. hose onto the hose adaptor, using the hose clamp to hold it in place. Put the other end of the hose over the floor drain.

FIG. 9 DRAIN HOSES

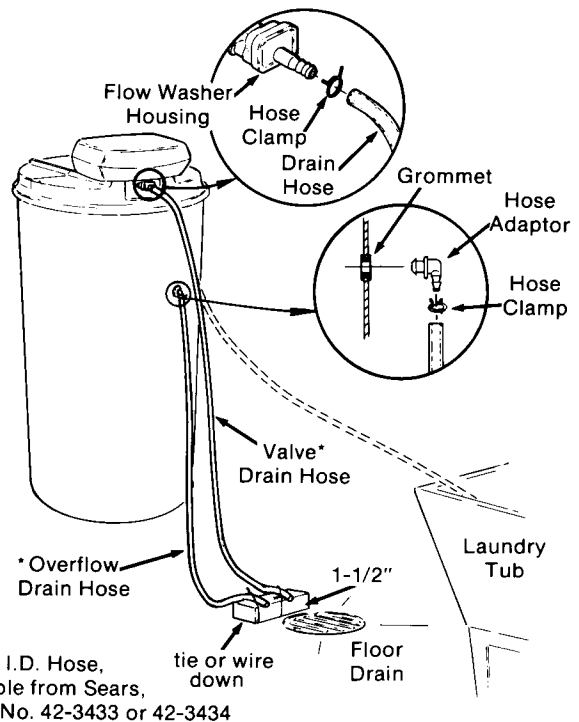

FIG. 10 SUMP — STANDPIPE DRAINS

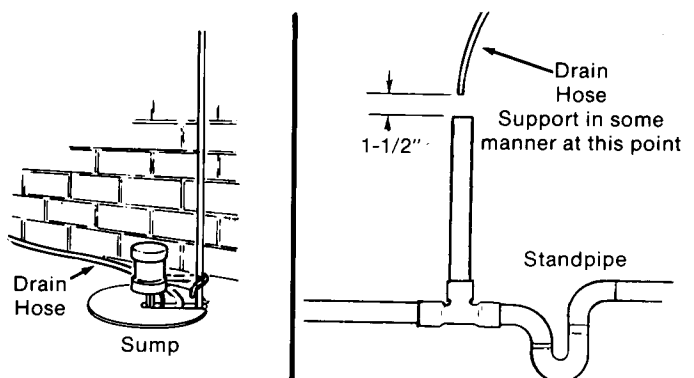
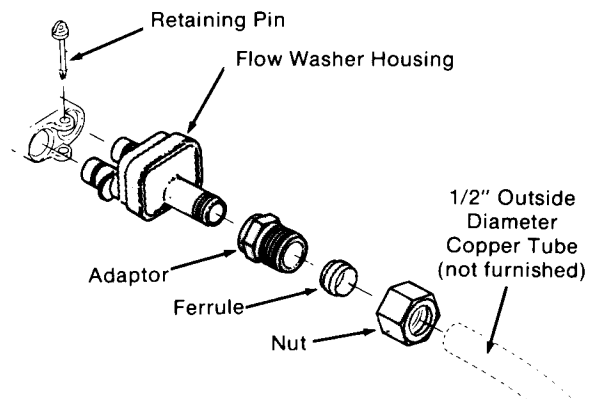

FIG. 11 COPPER DRAIN KIT
Stock No. 42-3438



STEP BY STEP GUIDES TO INSTALL YOUR SOFTENER

IMPORTANT NOTES:

- The salt tank overflow is for safety only. It directs over-fill water from the salt storage tank to the drain.
- Over-fill water must run downward through the hose. Do not raise the hose higher than the grommet and hose adaptor (FIG. 9).
- DO NOT connect to the valve drain hose you installed in step 9. A separate hose is needed for both drains.

11. TESTING YOUR PLUMBING WORK FOR WATER LEAKS.

Look at the picture in FIG. 12 showing your kind of bypass valve(s). On a single valve, slide the stem into SERVICE. On a 3 valve system, open the inlet and outlet valves and close the bypass valve.

- OPEN A HOT AND COLD WATER FAUCET TO LET AIR OUT OF THE SOFTENER AND HOUSE PIPES.
- Fully open the shut-off valve in the house main water pipe to turn on the water.
- After water from the faucets runs smooth with no more air bubbles, close them.
- Check your plumbing work for leaks and fix right away if any are found. READ THE CAUTION NOTE IN STEP 8, PAGE 10.

12. ADD WATER INTO THE SALT STORAGE TANK

Take off the salt storage tank cover. Use a broom handle, yard stick or other tool to push down on the salt platform (FIG. 13) until it rests on its legs. With a pail, pour water into the tank and fill to about 1/2" over the top of the salt platform.

13. FILL THE STORAGE TANK WITH SALT Fill the tank with NUGGET or PELLET water softener salt. **DO NOT use rock salts, or salt with iron removing additive.** (See page 17.) Before filling, BE SURE THE BRINEWELL COVER IS IN PLACE. DO NOT fill over the nozzle and venturi. It takes about the following pounds of salt to fill the tank.

Capacity 40, Model No. 625.340400 - 150 lbs.
 High Capacity 50, Model No. 625.340500 - 150 lbs.
 Ex. High Cap. 70, Model No. 625.340700 - 175 lbs.
 After filling, replace the salt storage tank cover.

FIG. 12 BYPASS VALVES

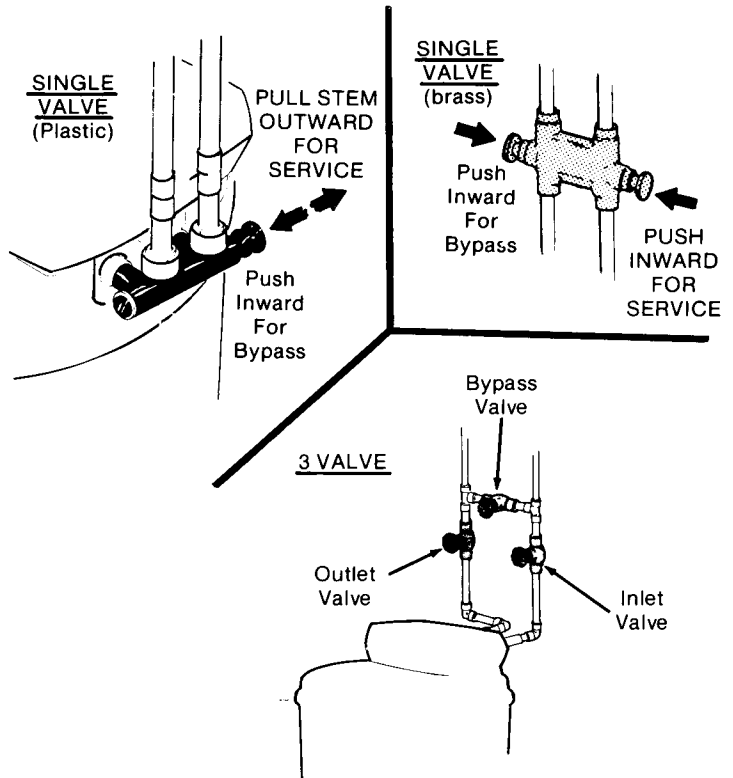
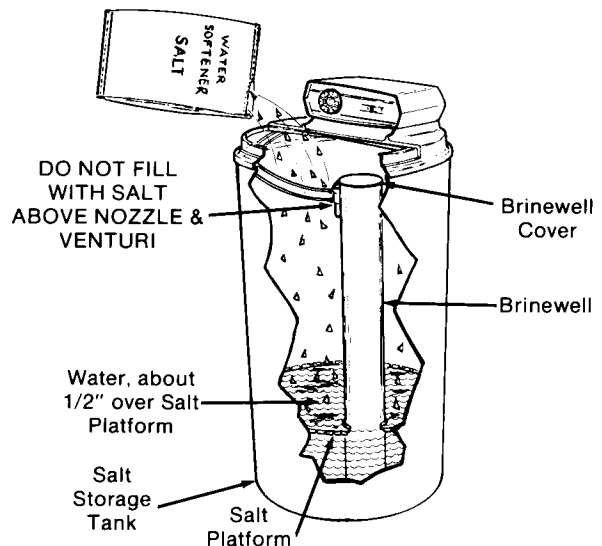

FIG. 13 ADD WATER AND FILL STORAGE TANK WITH SALT



NOTE: After filling the storage tank with salt for the first time, about 30 lbs. dissolves (melts) into the water to make a brine solution. From then on, the salt saver (See page 22) controls how much salt is used.

STEP BY STEP GUIDES TO INSTALL YOUR SOFTENER

14 INSTALL GROUNDING WIRE BETWEEN THE SOFTENER IN AND OUT PIPES

The house cold water pipe (iron or copper) is often used to ground all electric outlets in the home. Outlets are grounded to protect you from shock when you touch any electric appliance plugged into the outlet. If you didn't install a 3-valve bypass, or a brass single bypass valve (FIG. 12), the cold water pipe ground is broken.

- ▲ To restore the ground, take the clamps (2), screws (2), nuts (2) and ground wire that were in the small parts bag. Install across the iron or copper in and out pipes as shown in FIG. 14. Be sure good contact is made between the pipe and the clamps. Fasten the ground wire tightly between the clamps.

FIG. 14 COLD WATER PIPE GROUND

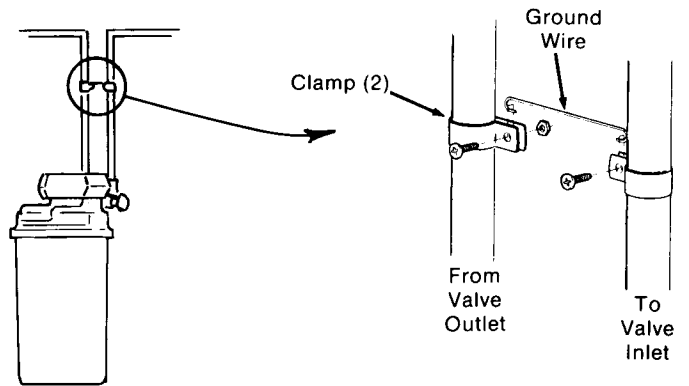
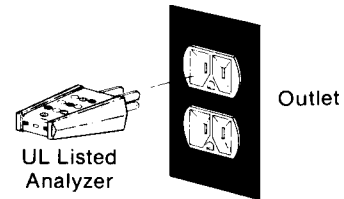

FIG. 15 CHECKING THE OUTLET



15. ELECTRIC POWER OUTLET FOR YOUR SOFTENER

The softener works on 24 volt, 60 Hz electric power. The included transformer changes standard 120 volt AC house power to 24 volts.

- ▲ You must plug the transformer into a 120 volt GROUNDED outlet only. Be sure the outlet is always "live" so someone cannot turn it off by mistake.

TO CHECK AN OUTLET FOR GOOD GROUNDING, use an Underwriters Laboratory (UL) approved circuit analyzer. (FIG. 15) You can get one at most electrical supply stores, and at Sears. When the analyzer is plugged into an outlet, it has lights to tell you if the outlet is grounded or not. Use it to check other outlets in your home.

- ▲ **TO GROUND THE OUTLET,** run a length of 14 gauge copper wire from the outlet box (FIG. 16) to a METAL COLD WATER PIPE. Use a metal clamp to fasten the wire tightly to the pipe.

IMPORTANT: Be sure the cold water pipe has direct metal to metal contact all the way to the ground. Plastic, rubber or other electrically insulating parts such as hoses, fittings, washers or gaskets can break the direct metal to metal contact. Also check the water meter (city water) or the well pump. Install #4 copper jumper wires, clamped tightly on both ends, across insulated parts (FIG. 17).

FIG. 16 GROUNDING THE OUTLET

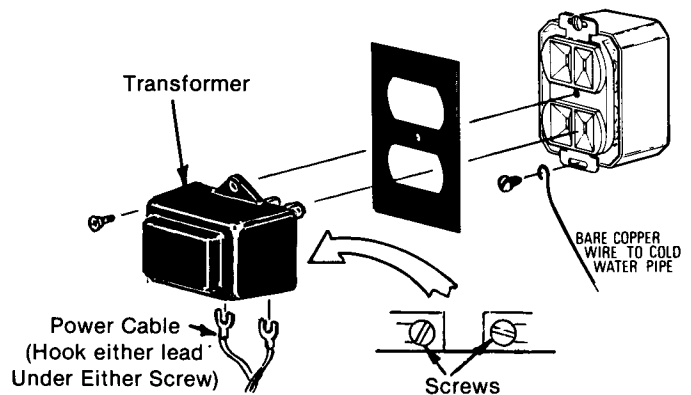
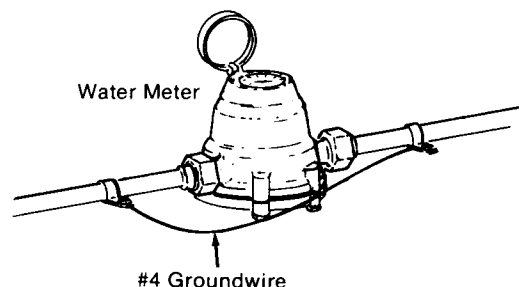

FIG. 17 WATER METER JUMPER WIRE



STEP BY STEP GUIDES TO INSTALL YOUR SOFTENER

continued from page 13 —

16. FASTEN THE POWER CABLE AND PLUG IN THE TRANSFORMER

Looking at FIG. 16, fasten the 2 power cable lugs (1 under each screw) to the transformer as shown. Tighten both screws.

Remove the center screw from the outlet plate. Plug in the transformer and use the center screw, or the screw with the transformer, to hold it in the outlet.

NOTE: The softener timer is factory set to start a regeneration (page 15 tells you what regeneration is) about 15 minutes after the transformer is plugged in. This first regeneration does 3 things.

1. It fills the salt tank with water to the level needed.

2. It gets all the air out of the resin tank.
3. It makes the resin bed (See page 15) ready for service.

The regeneration takes about 2 hours. After that, soft water goes into the house pipes. Then you can drain hard water from the water heater. (It will take a few days before your hot water is fully soft if you do not drain the heater). Open a hot water faucet until the water runs cold, then close faucet. The tank refills with soft water.

17. TURN ON THE GAS (OR ELECTRIC) SUPPLY TO THE HEATER AND LIGHT THE PILOT.

SET THE TIMER USING THE GUIDES BELOW

GUIDES FOR SETTING THE TIMER

SET THE TIME DIAL TO THE TIME OF DAY

- Turn the time dial to the right (↻) until AM is at the dot.
- From AM to 12 are the morning hours; from 12 to PM, the afternoon and evening hours.
- Turn the dial to the right until the present time of day is at the dot.

CAUTION: TURN TIME DIAL TO THE RIGHT (↻) ONLY. DO NOT TURN BACKWARDS.

NOTE: This timer is not made to be as accurate as a clock. Sometimes, it may need resetting to the correct time of day.

About 15 minutes after setting the time, a regeneration may begin. It will be over in 2 hours.

FIG. 18 TIME DIAL

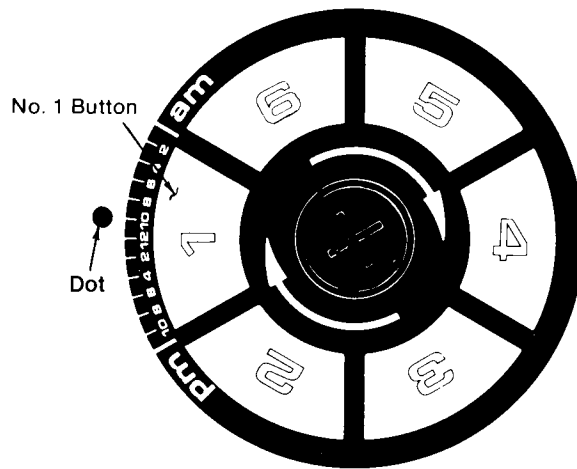

Your softener is factory set to regenerate (see page 15) every other day. When it regenerates, it uses the following amount of salt.

- Model No. 625.340400 Cap. 40 - 4.7 lbs.
- Model No. 625.340500 High Cap. 50 - 5.7 lbs.
- Model No. 625.340700 Ex. High Cap. 70 - 7.2 lbs.

For most families, this setting gives enough soft water for their needs. After setting the timer (above) the softener is ready to work for you.

Sometimes, a different regeneration setting is better. Two examples are:

- If your water has over 20 grains per gallon (GPG) hardness, with 6 or more persons in the family . . .
- If you want to “fine-tune” your softener for the most efficiency and salt saving.

TO “FINE-TUNE” YOUR SOFTENER,
SEE PAGE 18.

HOW YOUR WATER SOFTENER WORKS

SERVICE

When the softener is giving you soft water, it is called "Service". During service, hard water comes from the house main water pipe into the softener. Inside the softener resin tank is a bed made up of thousands of tiny, plastic resin beads (FIG. 19). As hard water passes through the bed, each bead attracts and holds the hardness minerals. This is called ion-exchanging. It is much like a magnet attracting and holding metals. Water without the hardness minerals (soft water) flows out of the softener and into the house soft water pipes.

After a period of time, the resin beads become coated with hardness minerals and they have to be cleaned. This cleaning is called regeneration. Regeneration is started by the timer. It takes place in 4 stages or cycles. These are:

- 1 BRINING
- 2 BRINE RINSE
- 3 BACKWASH
- 4 FAST RINSE

REGENERATION

1 BRINING: Salt, dissolved in water, is called brine. Brine cleans the hardness minerals from the resin beads. During brining, the brine is taken from the salt storage tank and put into the resin tank. Brine causes the resin beads to let go of the hardness minerals and they are carried to the drain. The amount of brine needed to clean the resin depends on 2 things —

- The amount of resin in the softener
- How fast the brine goes through the bed.

The nozzle and venturi (Fig. 20) make suction to take brine from the salt tank and put it into the resin tank. They keep the brine flow down to a very slow rate to get the best resin cleaning with the least salt.

A salt saver valve, in the salt storage tank, meters the amount of brine used for each regeneration. You can set it for different amounts (See page 22).

FIG. 19 WATER FLOW THROUGH THE SOFTENER IN SERVICE

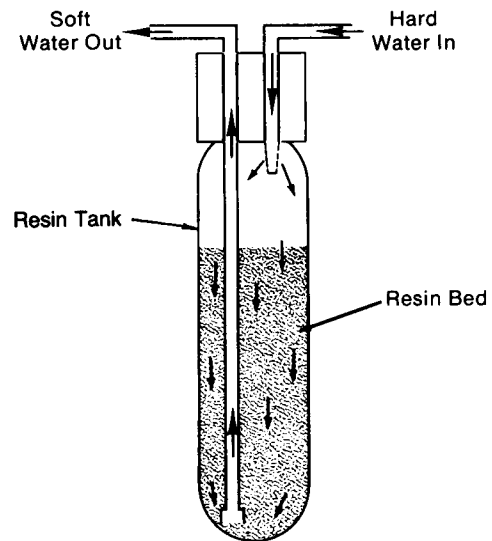
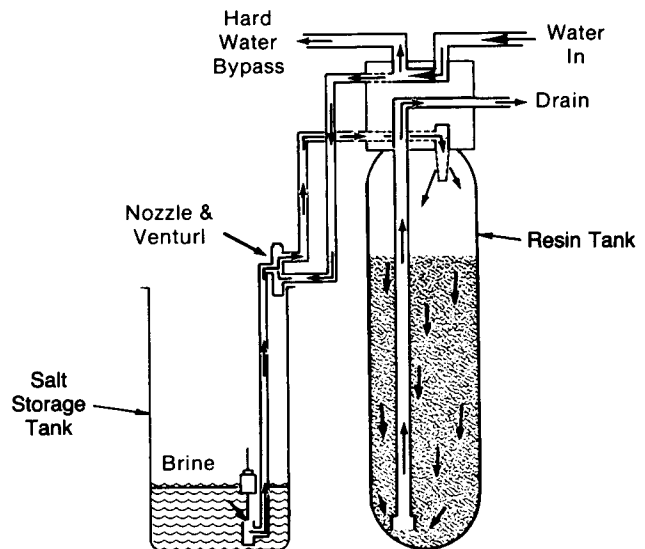

FIG. 20 WATER FLOW THROUGH THE SOFTENER IN BRINING AND BRINE RINSE



2 BRINE RINSE: After the preset amount of brine goes into the resin tank, the salt saver valve closes. Water keeps flowing in the same way as it did during brining except for the brine, which has stopped. Hardness minerals and brine flush from the resin tank to the drain. Brining and brine rinse together total about 77 minutes.

HOW YOUR WATER SOFTENER WORKS

3 **BACKWASH:** During backwash, water flows backwards or UP through the resin tank (FIG. 21). Flow is at a fast rate to flush iron minerals, dirt and sediments from the bed and to the drain. The bed lifts and expands for good cleaning. Fresh water also goes to the salt storage tank to make brine solution for the next regeneration.

The backwash cycle is about 11 minutes long.

4 **FAST RINSE:** Backwash is followed by a fast flow of water, down through the resin tank. The fast flow packs the resin bed and gets it ready for return to service. This cycle is about 6 minutes long.

After fast rinse, the softener returns to service. Hard water goes into the resin tank where the resin bed again takes out the hardness minerals. Soft water goes to the house soft water pipes.

AUTOMATIC BYPASS

During the 2 hour regeneration, HARD water goes through the softener valve and to the house pipes. If a faucet is turned on, hard water is there for your needs. However, you should not use hot water, if possible, because the water heater will refill with hard water. The softener regenerates from about 2:00 AM to 4:00 AM, a time when not much water is used.

Because the timer is not as accurate as a clock

FIG. 21 WATER FLOW THROUGH THE SOFTENER IN BACKWASH

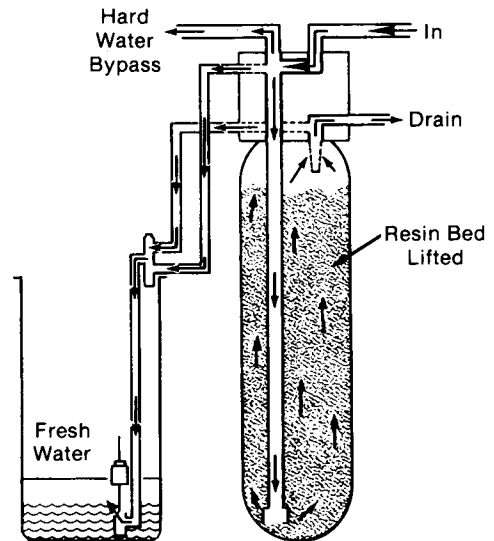
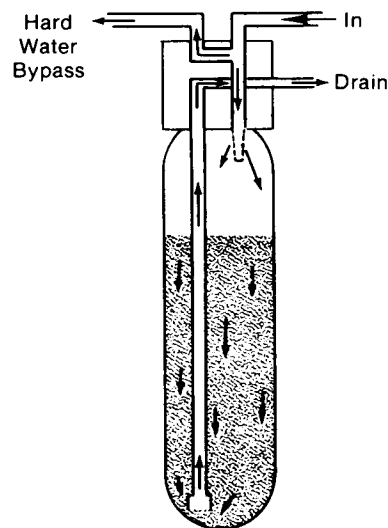

FIG. 22 WATER FLOW THROUGH THE SOFTENER IN FAST RINSE



(See page 14), regeneration time can vary some. If you get up early in the morning and you can hear the softener regenerating, change the time setting on the time dial. Move the dial ahead an hour or so. Then regeneration will start and end that much earlier and your water heater will not refill with hard water if a hot faucet is opened.

HOW YOUR WATER SOFTENER WORKS

EXTRA REGENERATION

Sometimes, you may run out of soft water. This can happen if more than the normal amount of water is used. For example, you will use more water if you have overnight guests. If you do run out of soft water, move the knob on the face plate to "EXTRA REGEN" (Fig. 23). Within a few minutes, a regeneration will start. In 2 hours, you will have soft water again.

The knob will return to "SOFT WATER" by itself, when the regeneration is over. You can't stop the extra regeneration after you have moved the knob to that position.

FIG. 23

EXTRA REGEN SOFT WATER

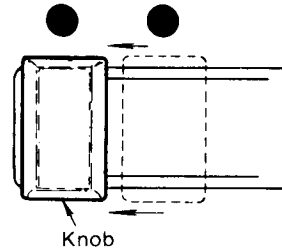

FIG. 24

VACATION

Going on a vacation, or a long business trip? Just move the knob on the face plate to "VACATION". The timer will keep on running and stay at the correct time, but regeneration will not happen. This will save you soft water and salt. When you return, move the knob back to "SOFT WATER".

IMPORTANT: If water to your outside faucets is softened, move the knob to "VACATION" while sprinkling the lawn or garden. In "VACATION" the softener bypasses hard water. If you're washing the car, keep the knob at soft water. Soft water is ideal for cleaning.

SOFT WATER

VACATION

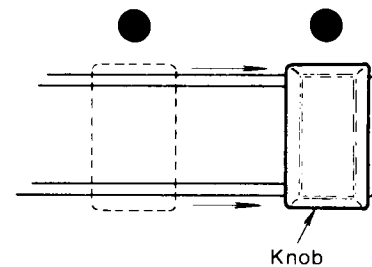
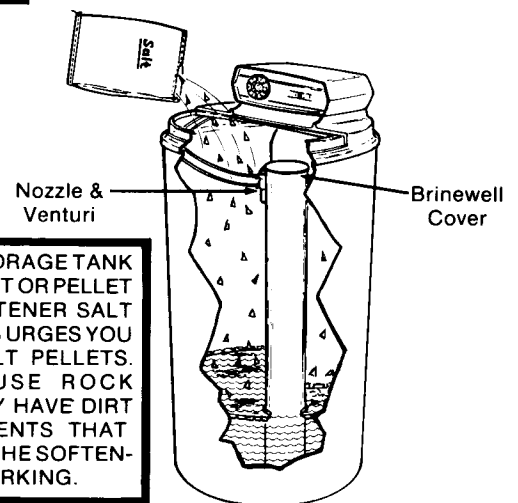

FIG. 25

BRINE and SALT

Brine (salt dissolved in water) is needed for each and every regeneration. The water for making brine is metered into the salt storage tank by the softener. However, you must keep the tank filled with salt.

WHEN TO REFILL WITH SALT: Check the salt level a few weeks after you install the softener and every week after that. Refill when the storage tank is about half full. Never let the softener use all the salt before refilling. Without salt, you will soon have hard water. Fill up to, but not over the nozzle and venturi (Fig. 25). **BE SURE THE BRINEWELL COVER IS IN PLACE.**



FILL THE STORAGE TANK WITH NUGGET OR PELLET WATER SOFTENER SALT ONLY. SEARS URGES YOU TO USE SALT PELLETS. DO NOT USE ROCK SALTS. THEY HAVE DIRT AND SEDIMENTS THAT WILL MAKE THE SOFTENER STOP WORKING.

NOTE: WATER SOFTENING SALT WITH IRON REMOVING ADDITIVES

Some salts have an additive to help the softener handle iron in the water supply. Although this additive may help to keep the softener resin clean, it may also release corrosive fumes that will weaken and shorten the life of some softener parts.

HOW TO "FINE-TUNE" YOUR WATER SOFTENER

It's not hard to "fine-tune" your softener (See page 14), but it does take a few minutes of your time to do it right. You may save up to 500 pounds or more of salt each year with proper tuning. Read the following carefully.

To have soft water all the time, the softener must regenerate 1 or more times in each 6 day period. How many times to regenerate (set on the time dial) and the salt saver setting to use depends on 2 things.

1. The number of people in your home - tells you how much water is used.
2. The grains per gallon (GPG) hardness of your water supply — listed on your water analysis report . . . see page 4.

The softener regenerates with salt (brine - see page 15). The pounds of salt needed each regeneration is set on the salt saver valve. The salt saver on your softener is set for . . .

- ...4.7 lbs. - Model No. 625.340400 Capacity 40
- ...5.7 lbs. - Model No. 625.340500 High Cap. 50
- ...7.2 lbs. - Model No. 625.340700 Ex. High Cap. 70

This setting gives you soft water for the longest time before the next regeneration is needed. However, you will get more gallons of soft water for each pound of salt used if the softener is regenerated more often at a lower salt saver setting. Over a period of time, a lower salt setting will save you salt, and money.

REGENERATION TABLE: The table on page 19, 20 or 21 makes it easy for you to pick the best regeneration and salt saver settings to use.

STEP 1 — Go down the left hand side of the table for your model, to the section listing the number of persons in your family, or the number of people in the house using water.

STEP 2 — Across the top of the table, find the column listing the grains per gallon hardness of your water.

STEP 3 — Read across and down the table to find the point where steps 1 and 2 meet. At this

meeting point, pictures of the time dial and salt saver show you the settings to use. The time dial picture shows you the button numbers to push inward (See below). The salt saver picture shows you the number to set your salt saver at (See page 22).

SETTING THE TIME DIAL FOR REGENERATIONS

The time dial (FIG. 26) turns all the time and makes 1 complete turn every 6 days. It has 6 buttons numbered from 1 through 6. Buttons pushed inward start regenerations. Buttons pulled outward will not start regenerations.

The picture of the time dial, in the regeneration table, shows the buttons to push inward for regenerations. Push those buttons inward. Be sure all others are outward.

FIG. 26 SET REGENERATIONS ON THE TIME DIAL

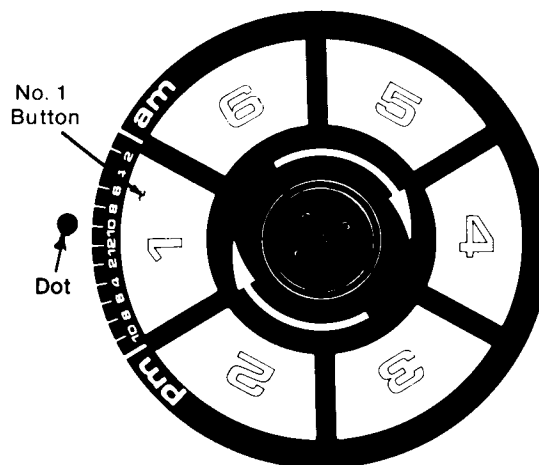

NOTES:

Buttons 1, 3 and 5 were pushed inward at the factory.

If a button at the top of the dial will not push inward, turn the dial to the right until it will.

TO RESET TIME OF DAY, SEE PAGE 14.

Regenerations start at about 2:00 AM.

This timer is not made to be an accurate time clock. Sometimes, it may need resetting to the correct time of day.

REGENERATION TABLE

MODEL NO. 625.340400

		WATER HARDNESS — GRAINS PER GALLON							
		Up to 5	6 to 10	11 to 15	16 to 20	21 to 25	26 to 30	31 to 35	36 to 40
1	PERSON IN THE HOUSEHOLD	3.4	3.4	3.4	3.4	3.4	3.4	4.7	4.7
2	PERSONS IN THE HOUSEHOLD	3.4	3.4	3.4	4.7	3.4	3.4	4.7	4.7
3	PERSONS IN THE HOUSEHOLD	3.4	3.4	3.4	3.4	4.7	3.4	4.7	4.7
4	PERSONS IN THE HOUSEHOLD	3.4	4.7	3.4	4.7	3.4	4.7	3.4	3.4
5	PERSONS IN THE HOUSEHOLD	3.4	3.4	4.7	3.4	4.7	3.4	3.4	3.4
6	PERSONS IN THE HOUSEHOLD	3.4	3.4	3.4	4.7	3.4	3.4	4.7	4.7
7	PERSONS IN THE HOUSEHOLD	4.7	4.7	4.7	3.4	3.4	4.7	4.7	
8	PERSONS IN THE HOUSEHOLD	4.7	4.7	4.7	3.4	3.4	4.7		
9	PERSONS IN THE HOUSEHOLD	3.4	3.4	3.4	3.4	4.7	REGENERATION TABLES FOR MODELS 625.340500 AND 625.340700 ARE ON PAGES 20 AND 21.		
10	PERSONS IN THE HOUSEHOLD	3.4	3.4	3.4	3.4	4.7			



IN THE TABLE ABOVE, THIS PICTURE IS THE TIME DIAL ON YOUR SOFTENER.

- Push numbered buttons inward for regenerations
- pull shaded buttons outward (see page 18)

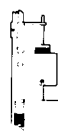

IN THE TABLE ABOVE, THIS PICTURE IS THE SALT SAVER ON YOUR WATER SOFTENER.

- Set Salt Saver to number shown — (see page 22)

REGENERATION TABLE

MODEL NO. 625.340500

		WATER HARDNESS — GRAINS PER GALLON									
		Up to 5	6 to 10	11 to 15	16 to 20	21 to 25	26 to 30	31 to 35	36 to 40	41 to 45	46 to 50
1	PERSON IN THE HOUSEHOLD	3.3	3.3	3.3	3.3	3.3	3.3	4.5	4.5	5.7	3.3
2	PERSONS IN THE HOUSEHOLD	3.3	3.3	3.3	4.5	3.3	3.3	4.5	4.5	3.3	3.3
3	PERSONS IN THE HOUSEHOLD	3.3	3.3	5.7	3.3	4.5	3.3	4.5	4.5	5.7	3.3
4	PERSONS IN THE HOUSEHOLD	3.3	4.5	3.3	4.5	3.3	4.5	3.3	3.3	3.3	3.3
5	PERSONS IN THE HOUSEHOLD	3.3	3.3	4.5	3.3	4.5	3.3	3.3	3.3	4.5	4.5
6	PERSONS IN THE HOUSEHOLD	3.3	3.3	3.3	4.5	3.3	3.3	4.5	4.5	5.7	
7	PERSONS IN THE HOUSEHOLD	4.5	4.5	4.5	3.3	3.3	4.5	4.5			
8	PERSONS IN THE HOUSEHOLD	4.5	4.5	4.5	3.3	3.3	4.5				
9	PERSONS IN THE HOUSEHOLD	5.7	3.3	5.7	3.3	4.5	5.7	<p>THE REGENERATION TABLE FOR MODEL 625.340400 IS ON PAGE 19.</p> <p>THE TABLE FOR MODEL 625.340700 IS ON PAGE 21.</p>			
10	PERSONS IN THE HOUSEHOLD	3.3	3.3	3.3	3.3	4.5					



IN THE TABLE ABOVE, THIS PICTURE IS THE TIME DIAL ON YOUR SOFTENER.

- Push numbered buttons inward for regenerations
- pull shaded buttons outward (see page 18)













































































































































































IN THE TABLE ABOVE, THIS PICTURE IS THE SALT SAVER ON YOUR WATER SOFTENER.

- Set Salt Saver to number shown — (see page 22)

REGENERATION TABLE

MODEL NO. 625.340700

WATER HARDNESS — GRAINS PER GALLON

		WATER HARDNESS — GRAINS PER GALLON									
		UP TO 10	11 TO 15	16 to 20	21 to 25	26 to 30	31 to 35	36 to 40	41 to 50	51 to 60	61 to 70
1	PERSON IN THE HOUSEHOLD	 2.8 	 2.8 	 2.8 	 2.8 	 2.8 	 3.8 	 3.8 	 5.4 	 2.8 	 3.8 
		 2.8 	 2.8 	 3.8 	 5.4 	 2.8 	 3.8 	 3.8 	 2.8 	 3.8 	 5.4 
3	PERSONS IN THE HOUSEHOLD	 2.8 	 5.4 	 2.8 	 3.8 	 2.8 	 5.4 	 3.8 	 5.4 	 2.8 	 3.8 
		 3.8 	 2.8 	 3.8 	 2.8 	 3.8 	 5.4 	 2.8 	 2.8 	 3.8 	 5.4 
5	PERSONS IN THE HOUSEHOLD	 5.4 	 3.8 	 2.8 	 3.8 	 5.4 	 2.8 	 2.8 	 3.8 	 5.4 	 7.2 
		 2.8 	 2.8 	 3.8 	 5.4 	 2.8 	 3.8 	 3.8 	 5.4 		
7	PERSONS IN THE HOUSEHOLD	 3.8 	 5.4 	 5.4 	 2.8 	 3.8 	 3.8 	 5.4 	 7.2 		
		 3.8 	 3.8 	 2.8 	 2.8 	 3.8 	 5.4 	 7.2 			
9	PERSONS IN THE HOUSEHOLD	 2.8 	 5.4 	 2.8 	 3.8 	 5.4 	 5.4 	<p>REGENERATION TABLES FOR MODELS 625.340400 AND 625.340500 ARE ON PAGES 19 AND 20.</p>			
		 2.8 	 5.4 	 2.8 	 3.8 	 5.4 	 7.2 				



IN THE TABLE ABOVE, THIS PICTURE IS THE TIME DIAL ON YOUR SOFTENER.

- Push numbered buttons inward for regenerations
- pull shaded buttons outward (see page 18)

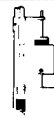

IN THE TABLE ABOVE, THIS PICTURE IS THE SALT SAVER ON YOUR WATER SOFTENER.

- Set Salt Saver to number shown — (see page 22)

HOW TO "FINE-TUNE" YOUR WATER SOFTENER

SETTING THE SALT SAVER

NOTE: Read page 18 before resetting the salt saver.

The salt saver (FIG. 28) is set by sliding a stem up or down. This raises or lowers a hose into the brine solution to control salt (brine) use. The sliding stem has number markings on it. It is factory set at...

...4.7 for 4.7 lbs. salt - Model No. 625.340400

...5.7 for 5.7 lbs. salt - Model No. 625.340500

...7.2 for 7.2 lbs. salt - Model No. 625.340700

To change the setting, do the following.

1. Remove the salt storage tank cover and brine-well cover (FIG. 27).

2. Take hold of the nozzle & venturi and lift up so you can turn the 2 plastic nuts to remove the red and white lines.

3. Lift the salt saver out of the brine-well.

4. The picture of the salt saver, in the regeneration table (page 19, 20 or 21), shows the number setting you should use. Move the adjusting stem (FIG. 28) up or down until this number shows in the window.

NOTE: Each small mark on the stem is 1/10 (0.1) of a pound of salt.

5. Put the salt saver back into the brine-well carefully so you don't move the adjusting stem.

6. Connect the red and white lines to the nozzle & venturi. **THE RED LINE GOES TO THE BOTTOM FITTING AND THE WHITE LINE TO THE TOP. DO NOT REVERSE OR THE SOFTENER WILL NOT WORK.** Turn the nuts tight by hand.

7. Be sure the nozzle & venturi guides are held by the slot in the brine-well. Then replace the brine-well cover and salt storage tank cover.

FIG. 27 REMOVING THE SALT SAVER FROM THE STORAGE TANK

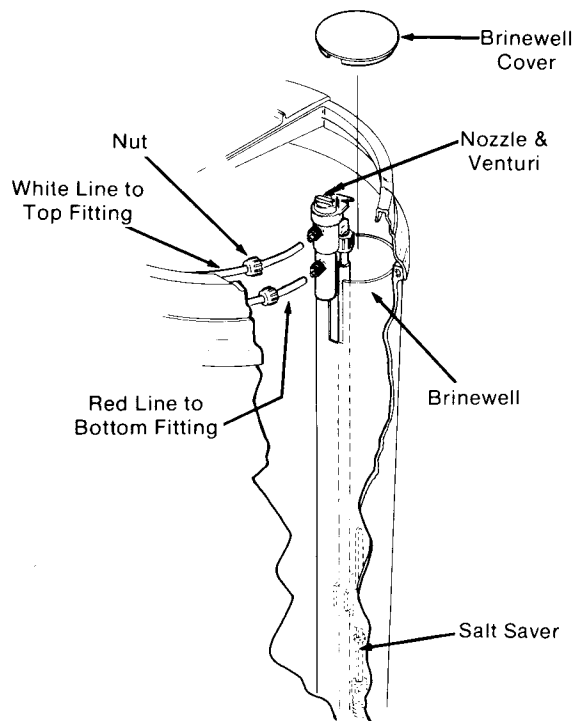
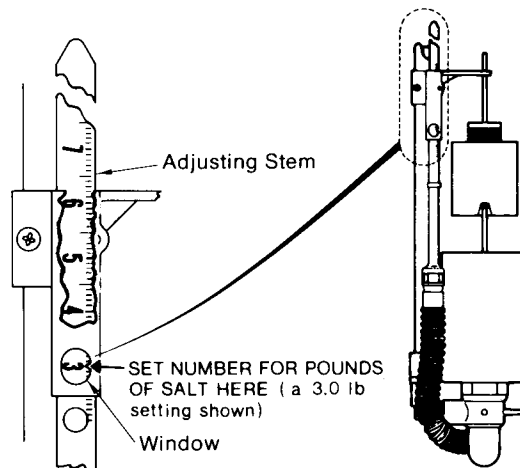

FIG. 28 SALT SAVER SETTING



HOW TO CARE FOR YOUR SOFTENER

CLEANING THE COVERS

To keep your new Sears water softener looking nice, apply a coat of paste wax and repeat once a year. When dusty, wipe it with a damp cloth to keep it sparkling.

- ▲ Never use cleaners having ammonia or abrasives. They may scratch and dull the surface.

CLEANING THE NOZZLE & VENTURI

A clean nozzle and venturi (FIG. 29) is a must for the softener to work right. This small unit moves brine from the salt storage tank to the resin tank during regeneration. If it becomes plugged with sand, silt, dirt, etc., it will not move the brine, and you will get hard water.

The nozzle & venturi parts (FIG. 29) are inside the plastic housing at the top of the salt saver (FIG. 27, page 22). Hold the housing with 1 hand and turn to the left (↶), to remove parts from the housing.

The filter and nozzle (FIG. 29) press-fit together and you can pull them apart. Take the nozzle out of the nozzle housing by turning to the left (↶).

- The venturi is inside the nozzle housing. Use a small scissors or tweezers to take it out by turning to the left. **BE CAREFUL NOT TO SCRATCH OR DAMAGE THE VENTURI.** If it's too tight, soak the parts in hot faucet water (or vinegar water) to loosen.

- Wash and rinse all parts in hot water until clean. Use small wire to clean plugged holes in the nozzle and venturi but, **DO NOT MISSHAPE, MAKE HOLES LARGER, OR SCRATCH SURFACES AROUND THE HOLES.** They will not work if damaged in any way.

After cleaning, put the venturi back into the nozzle housing, turning in until snug. Put the o-ring on the end of the nozzle housing and turn the nozzle into the housing. Push the small end of the filter into the nozzle.

With all parts together, dip into clean water and turn into the plastic housing on the salt

FIG. 29 NOZZLE & VENTURI PARTS

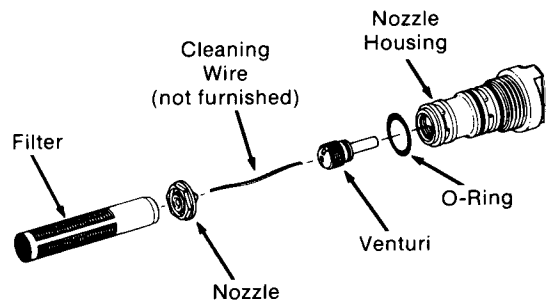

saver (FIG. 27). Tighten snugly **BY HAND ONLY.** Do not overtighten or you will break the plastic housing.

If you have to clean the nozzle & venturi quite often, you may decide to install a Sears sediment cartridge filter (See FIG. 1, page 4). This filter takes dirt and sediments out of the water.

GETTING IRON OUT OF THE SOFTENER

Your water softener takes hardness minerals (calcium and magnesium) out of the water. Also, it can control "clear water" iron up to the following maximums.

Model No. 625.340400 - 2 parts per million (ppm)
Model No. 625.340500 - 2 parts per million (ppm)
Model No. 625.340700 - 3 parts per million (ppm)

With clear water iron, water from a faucet is clear when first put into a glass. After 15 to 30 minutes, the water begins to cloud or turn rust colored. A water softener **WILL NOT** remove any iron if the water is cloudy or rusty as it comes from the faucet (called red water iron). To take red water iron out of water, or over the 2 or 3 ppm maximum of clear water iron, an iron filter or other equipment is needed. Your local Sears store has trained people to help you with iron water problems.

If your water supply has clear water iron, even though less than the 2 or 3 ppm maximum, regular resin bed cleaning is needed. Sears has resin bed cleaner, Stock No. 42-34425 for this. Clean the bed at least every 6 months. If iron shows up in the soft water before 6 months, clean more often. Printed instructions are on the resin bed cleaner bottle.

HOW TO CARE FOR YOUR SOFTENER

BREAKING A SALT BRIDGE

Sometimes, a hard crust or salt bridge forms in the salt storage tank, just above the salt platform. It is often caused by high humidity (dampness in the air) or the wrong kind of salt. When the salt bridges, an empty space forms between the water and salt. Then salt will not dissolve (melt) in the water to make brine. Without brine, the resin bed does not regenerate and you will have hard water.

If the storage tank is full of salt, it is hard to tell if you have a salt bridge. Salt is loose on top, but the bridge is under it. The following is the best way to check for a salt bridge.

Salt should lay right on top of the salt platform. Figure 30 shows the distance (D) from the salt platform to the top of the tank. Take a broom handle, or like tool, and make a pencil mark the correct distance (24", 26½" or 32") from one end. Carefully push the tool straight down into the salt. If a hard object is felt before the pencil mark gets to the top of tank, it's most likely a salt bridge. Carefully push into the bridge in a few places to break it. **DO NOT PUSH THE TOOL PAST THE PENCIL MARK OR YOU COULD DAMAGE THE SALT PLATFORM. DO NOT TRY TO BREAK THE SALT BRIDGE BY POUNDING ON THE OUTSIDE OF THE SALT TANK. YOU MAY DAMAGE IT.**

If the wrong kind of salt made the bridge, (See FIG. 25, page 17), take it out. Then fill the tank with nugget or pellet salt only.

KEEP THE SOFTENER FROM FREEZING

If the softener is installed where it could freeze (summer cabin, lake home, etc.), you must drain all water from it to stop possible freeze damage. To drain the softener —

1. Close the shut-off valve on the house main water pipe, near the water meter or pressure tank.
2. Open a faucet in the soft water pipes to vent pressure in the softener.
3. Looking at FIG. 12 on page 12, move the stem in a single bypass valve to bypass. Close the inlet

FIG. 30 A SALT BRIDGE

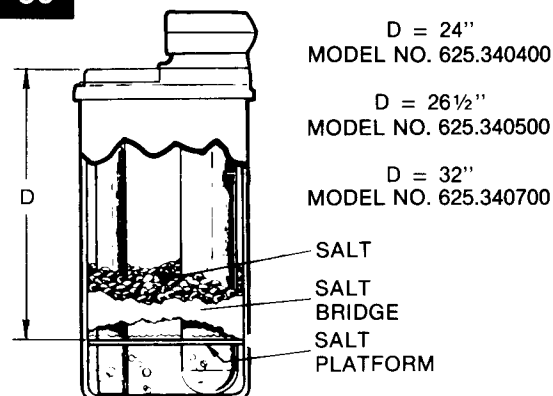
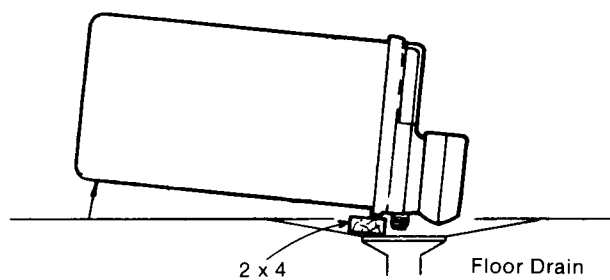

FIG. 31 DRAIN WATER FROM THE SOFTENER



and outlet valve in a 3 valve bypass system, and open the bypass valve.

(If you want water in the house pipes again, reopen the shut-off valve on the main water pipe).

4. Unplug the transformer at the wall outlet. Take off both drain hoses.
5. Take off the in and out piping nuts at the softener inlet and outlet (Fig. 8, page 10).
6. Looking at FIG. 31, lay a piece of 2 inch thick board near the floor drain. Move the softener close to the drain. SLOWLY and CAREFULLY tip it over until the rim rests on the wood block with the inlet and outlet over the drain. **DO NOT ALLOW THE SOFTENERS WEIGHT TO REST UPON THE INLET AND OUTLET FITTINGS OR THEY WILL BREAK.**
7. Tip the bottom of the softener up a few inches and hold until all water has drained. Leave the softener laying like this until you are ready to use it. Plug the inlet and outlet with rags to keep dirt, bugs, etc. out.

HELPFUL HINTS CHECKLIST . . . BEFORE YOU CALL FOR SERVICE

TO HELP YOU SAVE MONEY

If your water softener fails to work, make the following easy checks. Often, you will find what's wrong yourself and you won't have to call and wait for service. If, after making the checks, your softener still does not work right, call your Sears Service Department.

NO SOFT WATER

- 1 NO SALT IN THE STORAGE TANK** — Refill with salt (See page 17). In about 6 hours, use the Extra Regeneration Knob to start a regeneration.
- 2 TRANSFORMER UNPLUGGED AT THE WALL OUTLET, OR POWER CABLE LEADS LOOSE** — Plug in transformer or reconnect power cable leads and reset the time dial. Use the Extra Regeneration Knob to start a regeneration.
- 3 FUSE BLOWN, CIRCUIT BREAKER POPPED, OR CIRCUIT SWITCHED OFF** — Replace fuse, reset circuit breaker, or switch circuit on. Reset time dial and use Extra Regeneration Knob to start a regeneration.
- 4 KNOB ON FACE PLATE IN THE VACATION POSITION** — Return to SOFT WATER.
- 5 NO REGENERATIONS SET ON THE TIME DIAL** — Refer to pages 18 through 22 to find your regeneration and salt saver settings. Use the Extra Regeneration Knob.
- 6 MANUAL BYPASS VALVE (S) IN BYPASS POSITION** — See FIG. 12, page 12. Move stem in single bypass valve to SERVICE. In a 3 valve bypass, open the inlet and outlet valves, close the bypass valve.
- 7 SALT IN STORAGE TANK BRIDGED** - Refer to page 24 to break.

8 DIRTY, PLUGGED OR DAMAGED NOZZLE & VENTURI—Take apart and clean (See page 23) or replace damaged parts.

9 VALVE DRAIN HOSE PLUGGED — Hose must not have kinks, sharp bends, or any water flow blockage. See page 11.

WATER SOFT SOMETIMES, HARD SOMETIMES

A REGENERATIONS TOO FEW, OR SALT SAVER SET TOO LOW — See pages 18 through 22 to find correct settings.

B MORE WATER BEING USED— See pages 18 through 22 for correct regeneration and salt saver settings.

C HOT WATER USED WHEN SOFTENER IS REGENERATING—Avoid using hot water as the water heater refills with hard water. (See page 16)

D POSSIBLE INCREASE IN WATER HARDNESS — Ask your Sears retail or catalog store for a new water analysis.

E LEAKING FAUCET OR TOILET VALVE — A small leak will waste hundreds of gallons of water in a few days. Fix all plumbing leaks and always fully close faucets.

F LOOSE FITTING ON RED OR WHITE PLASTIC LINES — See FIG. 27 on page 22. Be sure the fastening nuts are tight.

DIMENSIONS AND SPECIFICATIONS

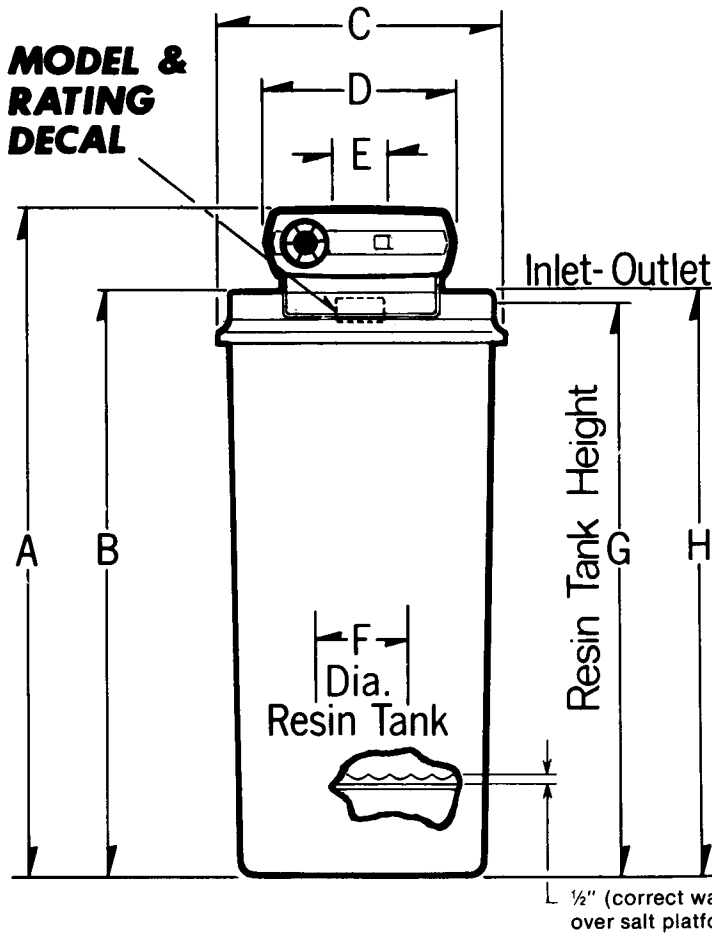

Dimension	CAPACITY 40 MODEL NO. 625.340400		HIGH CAPACITY 50 MODEL NO. 625.340500		EX. HIGH CAPACITY 70 MODEL NO. 625.340700	
	in.	cm.	in.	cm.	in.	cm.
A	39 1/4	99.7	41 1/4	106	46 3/4	118.7
B	34	86.4	36 3/4	93.3	41 1/2	105.4
C	17 1/2	44.5	17 1/2	44.5	17 1/2	44.5
D	12	30.5	12	30.5	12	30.5
E*	3 3/8	8.6	3 3/8	8.6	3 3/8	8.6
F	8	20.3	8	20.3	8	20.3
G	30	76.2	35	88.9	40	101.6
H	34	86.4	36 3/4	93.3	41 1/2	105.4

*from center of inlet to center of outlet

	MODEL NO. 625.340400	MODEL NO. 625.340500	MODEL NO. 625.340700
SOFTENER RATED CAPACITY (Grains) @ Pounds of Salt	15,000@4.7 (2.1 Kg) 12,500@3.4 (1.5 Kg)	16,500@5.7 (2.6 Kg) 15,000@4.5 (2.0 Kg) 12,600@3.3 (1.5 Kg)	21,000@7.2 (3.3 Kg) 18,900@5.4 (2.5 Kg) 15,500@3.8 (1.7 Kg) 12,000@2.8 (1.4 Kg)
SERVICE FLOW RATE (Gallons Per Minute) not over 15 pounds per square inch (psi) pressure loss	8.0 (30.3 Liters)	8.0 (30.3 Liters)	8.0 (30.3 Liters)
REGENERATION FLOW RATES (Gallon per Minute flow to drain)			
BRINING	.2 (.8 liters)	.2 (.8 liters)	.2 (.8 liters)
BRINE RINSE	.1 (.4 liters)	.1 (.4 liters)	.1 (.4 liters)
BACKWASH	1.4 (5.3 liters)	1.4 (5.3 liters)	1.8 (6.8 liters)
FAST RINSE	1.2 (4.6 liters)	1.2 (4.6 liters)	1.8 (6.8 liters)
TYPE OF ION EXCHANGE MATERIAL (RESIN)	High Capacity Resin		
AMOUNT OF RESIN (Cubic Feet)	.57 (.016 cu. m)	.60 (.017 cu. m)	.75 (.022 cu. m)
TYPE OF SALT NEEDED	Nugget or Pellet		
ALTERNATE TYPE OF SALT	— Pure, evaporated, compacted water softener salt —		
MAXIMUM WATER HARDNESS (Grains Per Gallon)	40	50	70
MAXIMUM "CLEAR WATER" IRON (Parts Per Million)	2.0	2.0	3.0

NOTE: The above flow rates obtained testing at 35 psi inlet pressure.

REPAIR PARTS . . . SEARS AUTOMATIC WATER SOFTENER

MODEL NO. 625.340400, CAPACITY 40
 MODEL NO. 625.340500, HIGH CAPACITY 50
 MODEL NO. 625.340700, EXTRA HIGH CAPACITY 70

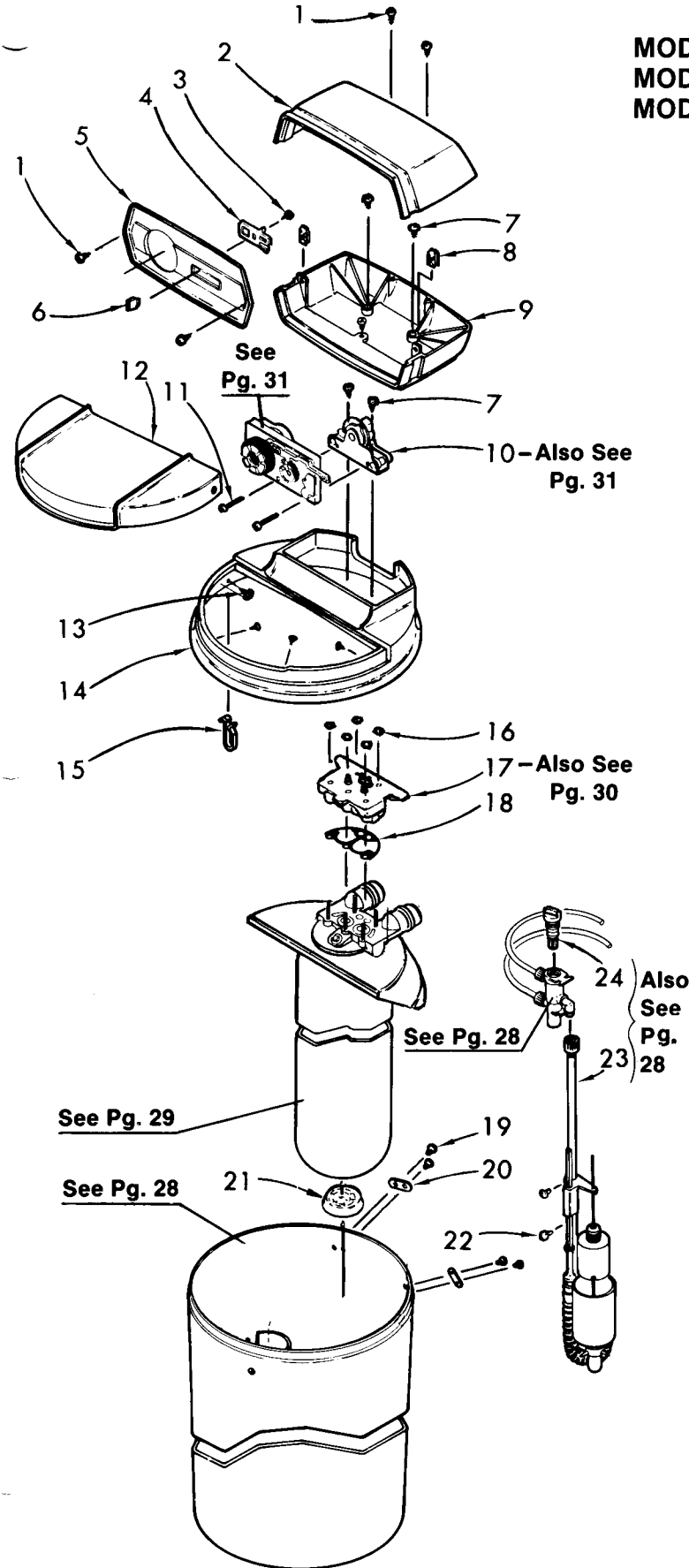

MAJOR ASSEMBLIES AND CONNECTING PARTS

Key No.	Part Number	Description
1	900562	Screw, #6 x 9/16 (4-req.)
2	1162300	Top Cover
3	900297	Screw, #6-32 x 3/8 Tap.
4	523606	Slide Actuator
5		Face Plate (Incl. Key Nos. 3, 4 and 6)
	7018787	— Model No. 625.340400
	7018779	— Model No. 625.340500
	7018795	— Model No. 625.340700
6	1173700	Actuator Knob
7	9006012	Screw, #8-18 x 1/2 Type 25 Tap (5-req.)
8	900596	Speed Nut (2-req.)
9	1162800	Bottom Cover
10	7011612	Cam Nest Assembly (Incl. 2 ea. Key No. 7)
11	901560	Screw, #8-32 x 1 Mach. (2-req.)
12	4013002	Cover Plate
◆		Decal, Cover Plate
	7018884	— Model No. 625.340400
	7018876	— Model No. 625.340500
	7018892	— Model No. 625.340700
13	9006045	Screw, #6-18 x 5/8 Tap. (4-req.)
14	1221110	Rim
15	501794	Hose Clip
16	114379	Nut, 1/4-20 Hex. (5-req.)
17	4020503	Valve Cap Assembly (Incl. Key No. 18)
18	503234	Gasket
19	9006048	Screw, #.250-10 x 3/4" (4-req.)
20	503262	Bracket (2-req.)
21	1211400	Spacer (Model 625.340400 only)
22	500942	Pin (2-req.)
23	4013013	Adjustable Brine Metering Assembly
24	4019101	Nozzle & Venturi Assembly
◆	7018907	Owners Manual (F642-14484)

◆ Not Illustrated

REPAIR PARTS . . . SEARS AUTOMATIC WATER SOFTENER

SALT STORAGE TANK AND SALT SAVER BRINE VALVE

MODEL NO. 625.340400, CAPACITY 40
 MODEL NO. 625.340500, HIGH CAPACITY 50
 MODEL NO. 625.340700, EXTRA HIGH CAPACITY 70

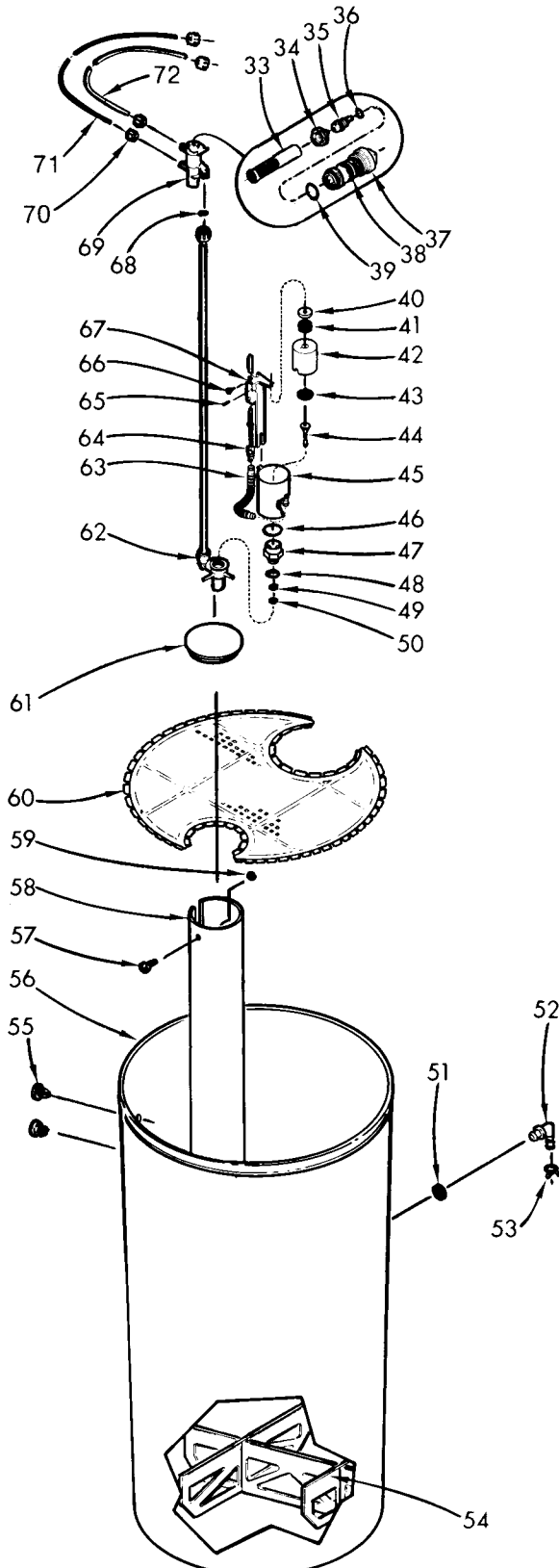

Key No.	Part Number	Description
33	1121200	Filter
34	502643	Nozzle - Brown
35	501760	Venturi - Brown
36	900064	O-Ring, 1/4" x 3/8"
37	500064	Nozzle & Venturi Housing
38	900042	O-Ring, 11/16" x 13/16" (2 req.)
39	900045	O-Ring, 5/8" x 3/4"
40	505957	Lead Washer
41	513860	Float Stop
42	516914	Float
43	516947	Float Seal
44	521306	Float Rod
45	521865	Float Cage
46	900832	O-Ring, 1-1/4" x 1-3/8"
47	517030	Nut
48	900186	O-Ring, 7/8" x 1"
49	516211	Seal
50	516924	Retainer — Bottom Seal
51	9003500	Grommet •
52	1103200	Hose Adaptor •
53	900431	Hose Clamp •
54	523119	Support Kit
55	1162900	Plug Button (2-req.)
56	4020601 4020602 4020002	Salt Storage Tank — Model No. 625.340400 — Model No. 625.340500 — Model No. 625.340700
57	900712	Screw, #6-32 x 7/16" Machine
58	522059 522060	Brinewell, Model 625.340400 & .340500 Brinewell, Model 625.340700
59	900706	Nut, #6-32
60	521961	Salt Platform
61	500283	Brinewell Cover
62	523334 523333	Elbow, Body & Riser — Model 625.340400 and 625.340500 — Model 625.340700
63	523040	Flexible Hose
64	4013012	Adjusting Stem
65	521867	Friction Device
66	900840	Screw, #6-20 x 1/4 Tap.
67	522068	Stem Housing & Rod Retainer
68	500284	Gasket
69	7011701	Nozzle & Venturi Adaptor ‡
70	1202600	Nut-Ferrule (4-req.)
71	501545	Pressure Line (red)
72	501014	Brine Line (white)

• Included in parts bag 4920001. See page 29
 ‡ Includes 2 of Key No. 70

REPAIR PARTS . . . SEARS AUTOMATIC WATER SOFTENER

RESIN TANK, VALVE ADAPTOR AND CONNECTING PARTS

MODEL NO. 625.340400, CAPACITY 40
 MODEL NO. 625.340500, HIGH CAPACITY 50
 MODEL NO. 625.340700, EXTRA HIGH CAPACITY 70

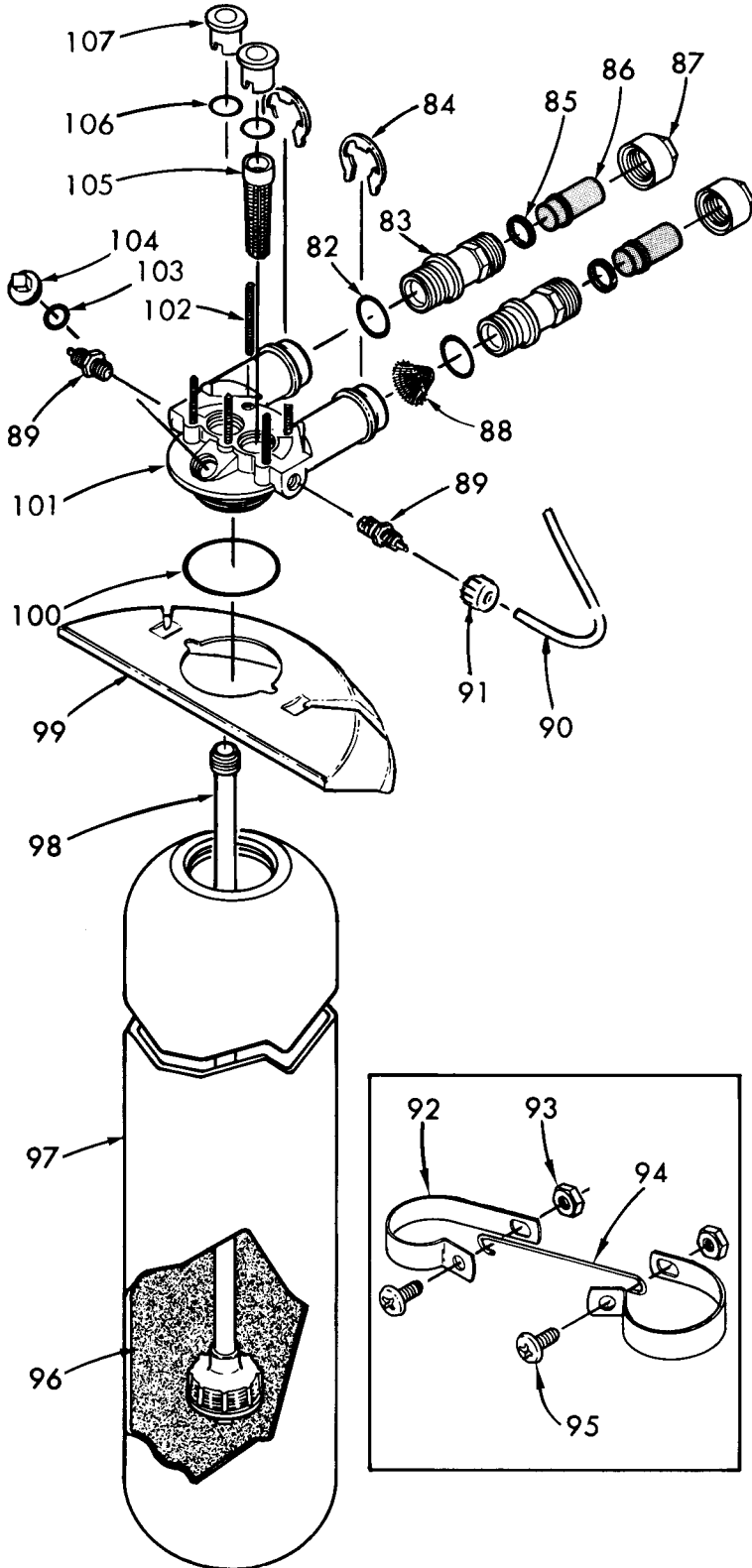

Key No.	Part Number	Description
82	900535	O-Ring, 15/16"x 1-3/16" (2-req.) •
83	507371	Installation Adaptor (2-req.) •
84	1205500	Clip (2-req.) •
85	900570	Washer (2-req.) •
86	507615	Installation Tube (2-req.) •
87	507369	Installation Nut (2-req.) •
88	900568	Screen (Inlet) •
89	7011816	Hose Adaptor (2-req.) ‡
90	1227300	Transfer Line
91	1202600	Nut-Ferrule (2-req.)
92	900373	"C" Clamp, Ground (2-req.) •
93	120375	Nut, "C" Clamp, 1/4-20 (2-req.) •
94	500726	Wire, Ground •
95	160505	Screw, "C" Clamp, 1/4-20 (2-req.) •
96	505644	Resin - Models 625.340400 & .340500
	501744	Resin - Model 625.340700
97		Resin Tank (Incl. Key No. 96)
	4020502	— Model No. 625.340400
	4013011	— Model No. 625.340500
	4019001	— Model No. 625.340700
98		Distributor
	2182802	— Model No. 625.340400
	2182800	— Model No. 625.340500
	2182801	— Model No. 625.340700
99	1204400	Harness
100	900279	O-Ring, 2-5/8"x 2-7/8"
101	4020504	Valve Adaptor (Incl. Key No. 18, page 27)
102	523136	Stud (5-req.)
103	900282	O-Ring, 7/8"x 1"
104	503227	Plug, Fill Hole
105	521404	Top Distributor
106	900100	O-Ring, 15/16"x 1-1/16" (2-req.)
107	507440	Insert Seat (2-req.)
◆	4920001	Parts Bag (Incl. all items on pages 28 and 29 marked with a •)

◆ Not Illustrated

• Included in parts bag 4920001. See page 29.
 ‡ Includes Key No. 91.

REPAIR PARTS . . . SEARS AUTOMATIC WATER SOFTENER

MODEL NO. 625.340400, CAPACITY 40
 MODEL NO. 625.340500, HIGH CAPACITY 50
 MODEL NO. 625.340700, EXTRA HIGH CAPACITY 70

VALVE CAP, SAFETY VALVE AND FLOW WASHER HOUSING

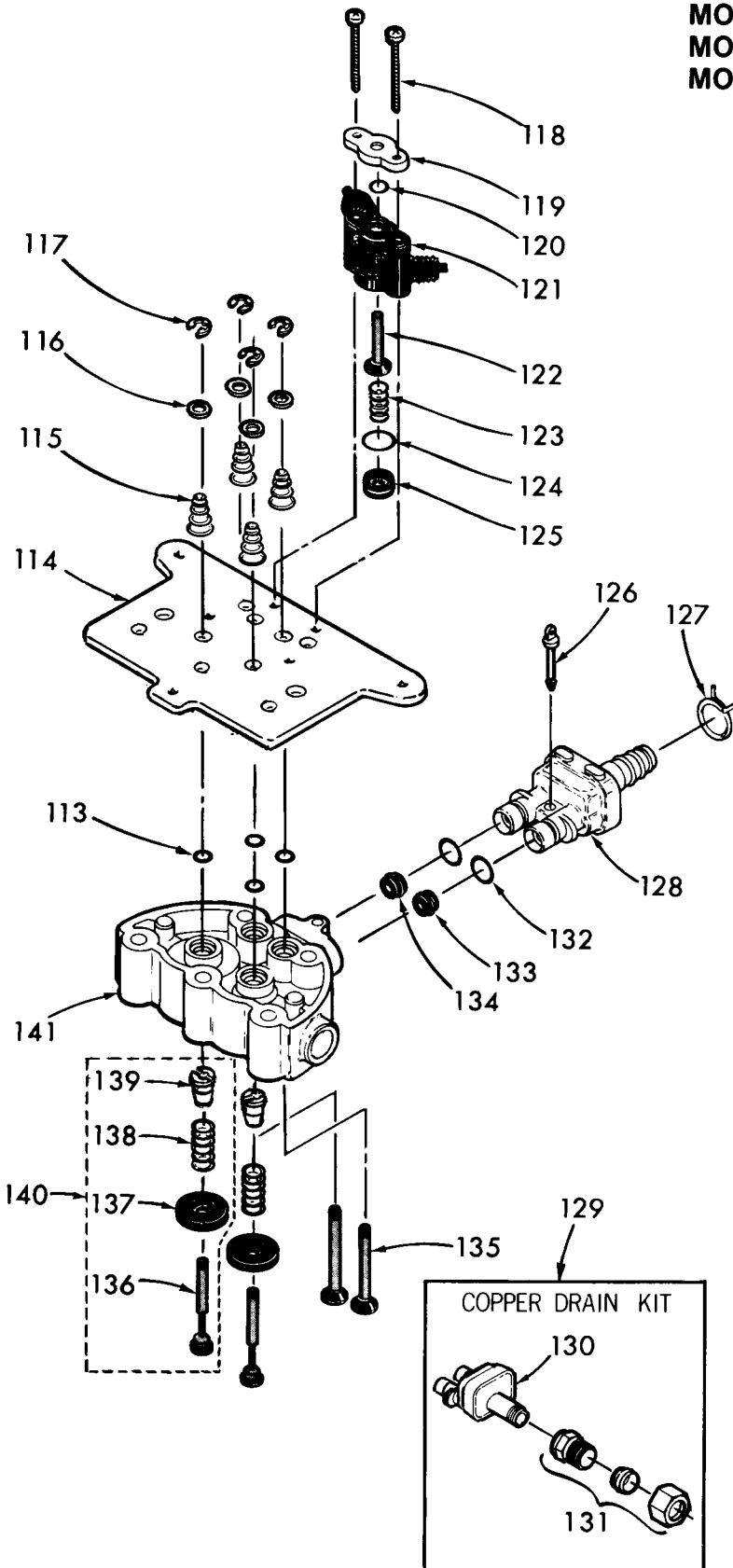

Key No.	Part Number	Description
113	900124	O-Ring, 3/16" x 5/16" (4-req.)
114	522829	Plate, Retaining
115	503276	Spring (4-req.)
116	503254	Washer (4-req.)
117	900288	Retainer Ring (4-req.)
118	9006013	Screw, #6-20 x 1-1/2 Type 25 Tap. (2-req.)
119	506541	Retaining Plate
120	900124	O-Ring, 3/16" x 5/16"
121	7011793	Safety Valve Body ‡
122	506540	Shut-off Stem
123	506531	Spring
124	900240	O-Ring, 7/16" x 9/16"
125	1175900	Cap
126	503278	Pin
127	900431	Hose Clamp
128	507494	Flow Washer Housing (Incl. Key No. 132)
129	507648	Copper Drain Kit (Incl. Key No. 130 and 131) OPTIONAL ACCESSORY
130	507647	Flow Washer Housing
131	504574	Adaptor
132	900060	O-Ring, 3/8" x 1/2" (2-req.)
133	501763 501228	Flow Washer (Backwash) — Models 625.340400 & .340500 — Model 625.340700
134	501227 501228	Flow Washer (Fast Rinse) — Models 625.340400 & .340500 — Model 625.340700
135	1116900	Drain Stem (2-req.)
136	505773	Stem (2-req.)
137	505788	Seal (2-req.)
138	1219600	Spring (2-req.)
139	1228800	Stem Ferrule (2-req.)
140	503390	Stem & Seal (Incl. items within dotted lines & Key No. 113, 115, 116 and 117)
141	4020505	Valve Cap (Incl. Key 18, page 27)

‡ Includes 2 of Key No. 91, page 29.

REPAIR PARTS . . . SEARS AUTOMATIC WATER SOFTENER

MODEL NO. 625.340400, CAPACITY 40

MODEL NO. 625.340500, HIGH CAPACITY 50

MODEL NO. 625.340700, EXTRA HIGH CAPACITY 70

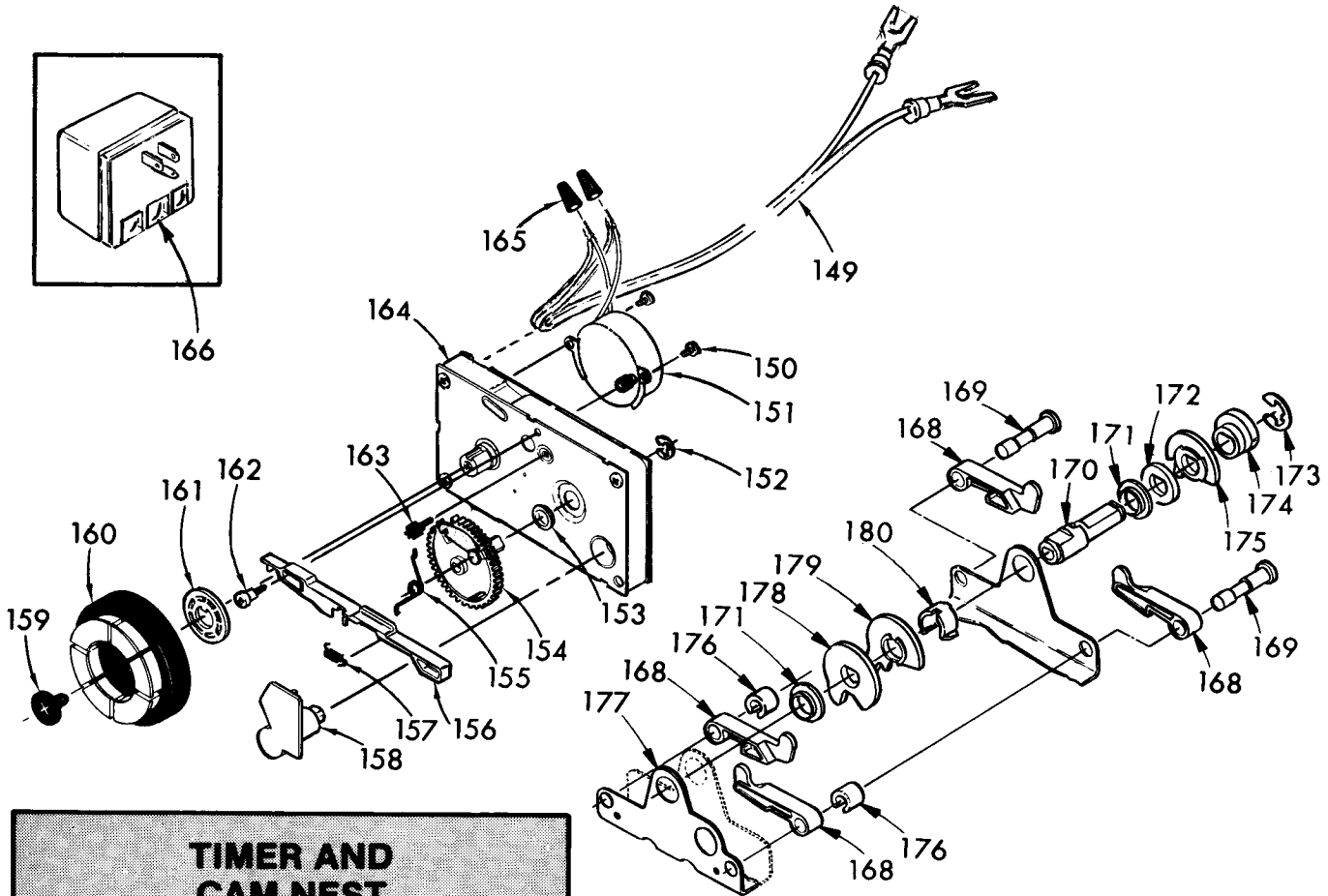

TIMER AND CAM NEST

Key No.	Part Number	Descriptions
149	1263500	Power Cable
150	900290	Screw, #4-24 x 1/4 Tap. (2-req.)
151	2198200	Motor, 24V - 60 Hz (Incl. 2 ea. Key No. 150)
152	900287	Retainer Ring
153	503287	Bushing
154	4000028	Gear Kit (Incl. Key Nos. 152, 153, 155, 156, 157, 162 and 163)
155	503313	Spring
156	1230000	Push Arm
157	1234900	Spring (Extension)
158	523603	Actuating Lever
159	523602	Screw
160	2162400	Dial, Time
161	523604	Clutch
162	509667	Shoulder Screw

Key No.	Part Number	Descriptions
163	522140	Regeneration Drive Gear
164	523655	Timer Assembly (Incl. Key Nos. 152 thru 157, 162 and 163)
165	501653	Wire Nut (2-req.)
166	7018703	Transformer, 24V - 10VA
—	—	—
168	503286	Actuator Arm (4-req.)
169	1297600	Support Shaft (2-req.)
170	7011418	Cam Shaft
171	7011434	Bearing (2-req.)
172	523298	Cam #3
173	900096	Retainer Ring
174	523300	Cam, Safety Valve
175	1195600	Cam #4
176	1297700	Collar (2-req.)
177	503233	"U" Plate
178	523296	Cam #1
179	523297	Cam #2
180	7011442	Clip

Sears

**OWNERS
MANUAL**

SERVICE

MODEL NOS.

**625.340400
CAPACITY 40**

**625.340500
HIGH CAPACITY 50**

**625.340700
EXTRA
HIGH CAPACITY 70**

**HOW TO ORDER
REPAIR PARTS**

**TELL SEARS YOU
WANT IT INSTALLED
THEN RELAX**

Kenmore

WATER SOFTENERS

Now that you have purchased your water softener, should a need ever exist for repair parts or service, simply contact any Sears Service Center. Be sure to provide all pertinent facts when you call or visit

The model number of your water softener is found on the rating decal. This decal is on the inside, front of the storage tank rim.

WHEN ORDERING REPAIR PARTS, ALWAYS GIVE THE FOLLOWING INFORMATION:

—PART NUMBER	—PART DESCRIPTION
—MODEL NUMBER	—NAME OF ITEM

All parts listed may be ordered from any Sears Service Center.

If the parts you need are not stocked locally, your order will be electronically transmitted to a Sears Repair Parts Distribution center for handling.

When Sears arranges the installation, you can be sure the job is done right. We will arrange for professional workmanship...and we'll take care of the entire project. What's more, during installation you get insured protection...against property damage and also against accidents to workmen. All you have to do is talk to your Sears salesperson or call your nearest Sears store today for detailed information.

Sears, Roebuck and Co., Chicago, Ill. 60684 U.S.A.