

SEARS

**OWNERS
MANUAL**

**MODEL NOS.
625.3488003
625.348812**

CAUTION
Read All Safety
Guides Before
You Start to
Install Your
Softener

SAVE THIS MANUAL

**AVOID UNNEEDED
SERVICE CALLS...**
Read the HELPFUL
HINTS CHECKLIST on
page 24. The program-
ming guides on the
underside of the Salt
Storage Tank Cover are
also helpful.

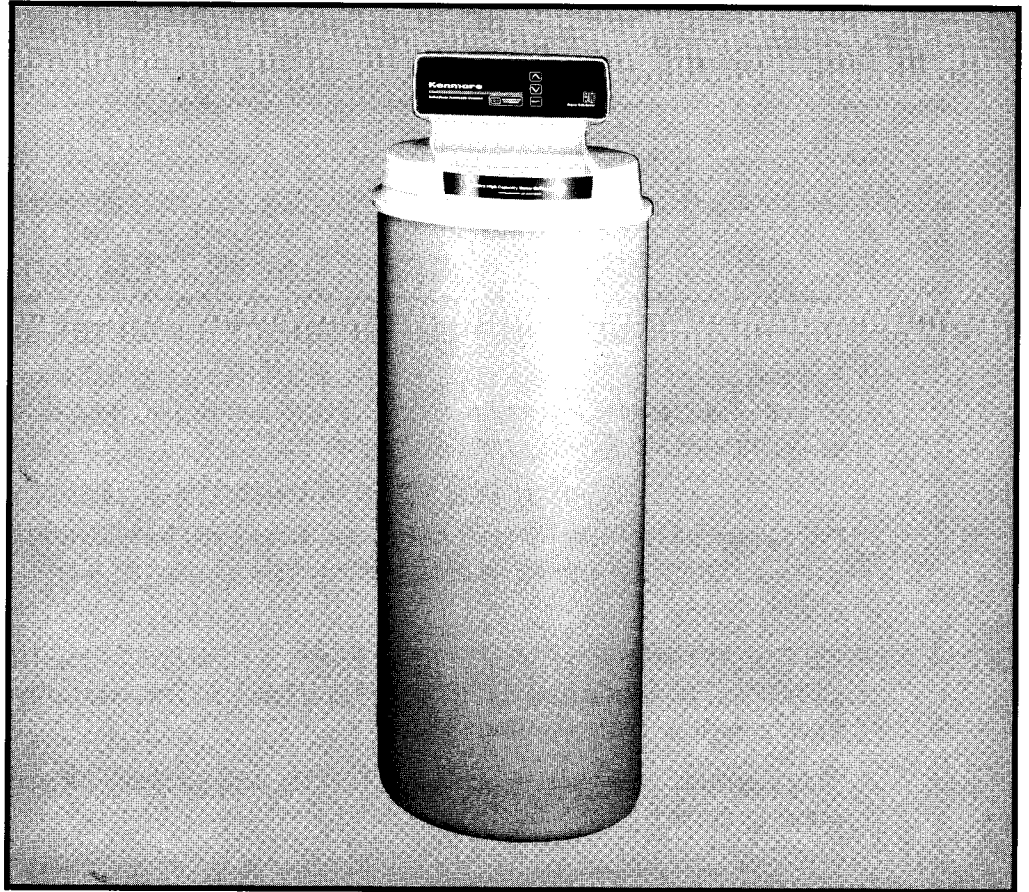

Kenmore
Extra High Capacity 80
WATER SOFTENERS

- HOW TO INSTALL —
- HOW IT WORKS —
- CARE OF —
- SPECIFICATIONS —
- REPAIR PARTS —

Sears, Roebuck and Co., Chicago, Ill. 60684 U.S.A.

WARRANTY

SEARS RESIDENTIAL WATER SOFTENER

FULL ONE YEAR WARRANTY ON WATER SOFTENER

For one year from the date of purchase, when this water softener is installed and maintained in accordance with our instructions, Sears will repair, free of charge, defects in material or workmanship in this water softener.

FULL TEN YEAR WARRANTY AGAINST LEAKS

For ten years from the date of purchase, Sears will furnish and install a new current model water softener tank or salt storage drum, free of charge, if either the tank or drum develop a leak.

TO OBTAIN WARRANTY SERVICE, SIMPLY CONTACT THE NEAREST SEARS SERVICE CENTER THROUGHOUT THE UNITED STATES. This warranty applies only while this product is in use in the United States.

This warranty gives you specific legal rights, and you may have other rights which vary from state to state.

Sears, Roebuck and Co., Dept. 731-CR-W, Sears Tower, Chicago, IL 60684

If you want your water softener professionally installed, talk to your Sears Salesman. He will arrange for a prompt, quality installation by Sears Authorized Installers.

SEARS INSTALLATION POLICY

All installation labor arranged by Sears shall be performed in a neat, workmanlike manner in accordance with generally accepted trade practices. Further, all installations shall comply with all local laws, codes, regulations and ordinances. Customer shall also be protected, during installation, by insurance relating to Property Damage, Workman's Compensation and Public Liability.

SEARS INSTALLATION WARRANTY

In addition to any warranty extended to you on the Sears merchandise involved, which warranty becomes effective the date the merchandise is installed, should the workmanship of any Sears arranged installation prove faulty within one year, Sears will, upon notice from you, cause such faults to be corrected at no additional cost to you.

TABLE OF CONTENTS

		PAGE NO.
<u>SECTION 1</u>	Unpacking The Softener	4
	Safety Guides	4
<u>SECTION 2</u>	Before You Start To Install Your Softener	5-9
	Water System Tests	5
	Where To Install The Softener	6
	Plan <u>How</u> You Will Install The Softener	6-9
	Tools, Pipe, Fittings and Other Materials Needed	7-9
<u>SECTION 3</u>	Step By Step Guides To Install Your Softener	10-16
	Install Inlet-Outlet Adaptors, or Sears Plastic Bypass Valve	10
	Install Sears Brass Bypass Valve, or 3-Valve Shutoff	11
	Connect In and Out Pipes To Softener	12
	Fasten Drain Hoses To Softener	12-13
	Check Your Plumbing Work For Leaks	14
	Connect Softener To Electrical Power	15
	Check List of Step By Step Installing Guides	15
<u>SECTION 4</u>	Softener Start-Up	16-17
	Sanitizing The Water Softener	16
	Make The Face Plate Timer Settings	16-17
	Filling The Salt Storage Tank With Salt	17
<u>SECTION 5</u>	How Your Water Softener Works	18-21
	Face Plate Timer Features	18
	Service - Regeneration - Automatic Bypass - Electronics	21
	Wiring Connection Diagram	21
<u>SECTION 6</u>	Care of Your Softener	22-25
	Checking The Salt Storage Level and Refilling	22
	Breaking a Salt Bridge	22
	Cleaning The Outer Covers	23
	Cleaning The Nozzle and Venturi	23
	Cleaning Iron From The Resin Bed	23
	Protect Softener From Freezing	24
	Check List Before You Call For Service	24-25
<u>SECTION 7</u>	Other Things To Know	26-27
	Sweat Soldering Tips	26
	Dimensions and Specifications	27
<u>SECTION 8</u>	Repair Parts	28-31
	How To Order Repair Parts	Back Cover

SECTION 1

UNPACKING, SAFETY GUIDES

UNPACKING – This owners manual was on a cardboard packing piece. On the same cardboard piece are all the small parts you will need to install the softener (not including plumbing pipe and fittings). So you don't lose any parts, keep them on the cardboard until you are ready to use them. Remove all other cardboard pieces, foam packings, tape, etc., from the softener and discard.

Check the softener for shipping damage. If you find damage, call your Sears store for help.

Use care when handling the softener. DO NOT turn upside-down. DO NOT drop, or set on sharp objects that will make a hole in the bottom.

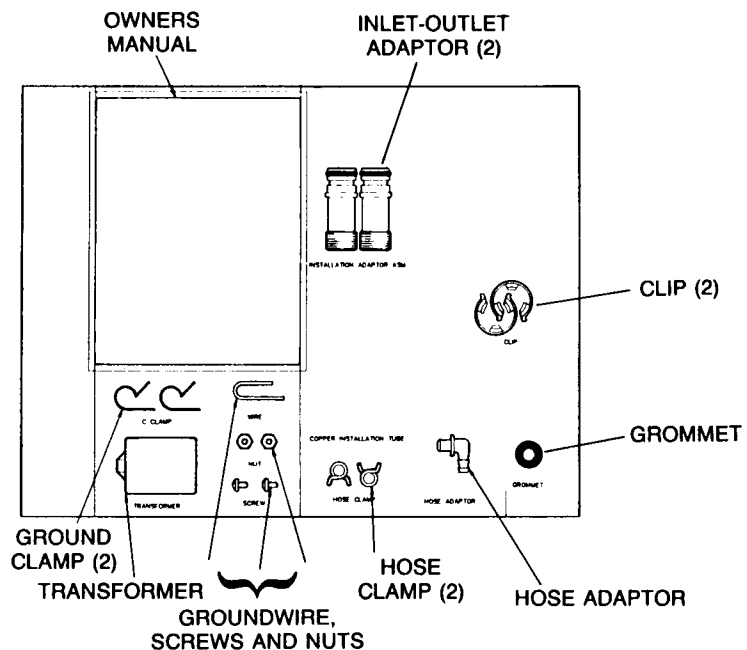

SAFETY GUIDES

▲ Read all steps, guides and rules carefully before installing and using your new water softener. Follow all steps exactly to correctly install. Failure to follow them could cause personal injury or property damage. Reading this book will also help you to get all of the benefits from your water softener.

▲ Your water softener will remove hardness mineral and "clear water" iron from water, up to the limits shown on page 27. It will not remove other types of iron, acids, tastes and odors, etc. It will not purify polluted water or make it safe to drink.

▲ Check with your local public works department for plumbing, electric and sanitation codes. You must follow their guides as you install your softener.

▲ Use only LEAD-FREE SOLDER AND FLUX, as required by Federal and State codes, when installing soldered copper plumbing.

▲ Protect the softener and piping from freezing. Damage from freezing voids the softener warranty. See page 24.

PLEASE READ AND COMPLY WITH THE FOLLOWING GUIDES TO PREVENT DAMAGE TO THE SOFTENER OR OTHER PROPERTY, PERSONAL INJURY, OR POSSIBLE FATAL SHOCK.

▲ THIS SOFTENER WORKS ON 24 VOLTS ONLY. BE SURE TO USE THE TRANSFORMER INCLUDED, AND PLUG IT INTO A 120V OUTLET.

▲ Be sure the electric outlet for the softener is grounded the right way.

▲ Unplug the transformer right away if the power cable should become damaged or frayed. Make repairs before plugging back into the power outlet.

▲ Always unplug the softener from electrical power before removing outer valve covers.

When you see this sign in the book, ▲ something could be damaged, or someone hurt, if the guide is not followed exactly.

SECTION 2

BEFORE YOU START TO INSTALL

HELPFUL INFORMATION

If you know little about plumbing skills, we suggest you get a book on the subject. There are many good books for do-it-yourselfers on the

basics of plumbing. You can get a low cost book from Sears Plumbing and Heating departments that will help you. Some basic sweat soldering tips are on page 26 of this manual.

WATER SYSTEM TESTS

HAS YOUR WATER SUPPLY HAD A CHEMICAL ANALYSIS? Sears has many kinds of water treating units (see page 6) to correct different water problems. To know the kind and size of unit you need, you must first know what elements are in your house water supply. A chemical analysis shows the type and amounts of elements in water. If your water needs analysis, call or write your nearest Sears store for help.

CHECK YOUR WATER PRESSURE — For your softener to work right, a water pressure of no lower than 20 pounds per square inch (psi) is needed in the house water pipes. The highest pressure allowed in the water pipes is 120 psi. If pressure is over 120 psi, buy and install a pressure reducing valve in the water inlet pipe to the softener. NOTES: If water pressure during the day is 100 psi or more, pressure during the night may go over 120 psi...Adding a pressure reducing valve may reduce the flow.

If you have a well water system, look at the pressure gauge to find the water pressure. Call your local water department if you have city water.

They will tell you what the water pressure is where you live.

CHECK YOUR WATER FLOW RATE — A water flow of at least 3 gallons per minute is needed. A lower flow will keep your softener from working as well as it should. To make an easy check of your flow rate, do the following. You will need a 1 gallon container (can, jar, pail, etc.).

1. Fully open 2 cold water faucets close to the point water enters the house.
2. With both faucets open, fill the gallon container at 1 faucet while looking at a watch or clock to see how many seconds it takes.
3. Empty the container and go to the second faucet (be sure BOTH faucets are still on). Fill the gallon container at the second faucet and see how many seconds it takes.
4. Turn off both faucets. Now add the number of seconds it took to fill the container at both faucets.
5. A total of 90 seconds, or less, means the system flow rate is good.

FACTS AND FIGURES TO KEEP

Fill in the blanks below and keep this book in a safe place so you always have these facts.

Water Softener Model No. † _____
Serial Number _____
Date Installed _____
Water Hardness _____ Grains Per Gallon

Iron Content _____ Parts Per Million
*pH _____ Taste And/Or Odor _____
Water Pressure _____ Pounds/Square Inch
Water Flow Rate _____ Gallons Per Minute

SODIUM INFORMATION: Water softeners using sodium chloride for regeneration add sodium to the water. Persons who are on sodium restricted diets should consider the added sodium as part of their overall sodium intake.

For example, if your water supply is 15 grains hard, you would have to drink 3 quarts of softened water

to consume 335 milligrams of sodium. That is equivalent to eating 2½ slices of white bread.

Persons who are concerned about their drinking water should consider a Sears Drinking Water System that will remove or reduce in excess of 90% of the sodium and other drinking water contaminants.

SECTION 2

BEFORE YOU START TO INSTALL

WHERE TO INSTALL THE SOFTENER

Think of the following points as you choose a place to put your softener. (See FIG. 1).

- Place as close as possible to the pressure tank (well water) or water meter (city water).
- Place as close as possible to a water drain such as a floor drain, laundry tub, sump or standpipe.
- ▲ • Connect to the house main water pipe **BEFORE THE WATER HEATER**. Temperature of water going through the softener must not be more than 120 F (49 C).
- Keep outside faucets on hard water to save soft water and salt.
- ▲ • **DO NOT** install in a place where the softener could freeze. Freeze damage voids the warranty

by Sears, Roebuck and Co. (See page 24).

- ▲ • Put the softener in a place water damage is least likely to occur if it develops a leak. Sears or the manufacturer will not repair or pay for water damage.
- ▲ • A 120V electric outlet, to plug the transformer into, is needed within 10 feet of the softener (the softener has a 10 foot power cable). Be sure the outlet and transformer are in an inside place, to protect from wet weather.
- ▲ • When installing in an outside location, you must take the steps necessary to assure the softener, installation plumbing, and wiring, are as well protected from the elements, contamination, vandalism, etc., as when installed indoors.
- ▲ • Keep the softener out of direct sunlight. The sun's heat can melt plastic parts.

FIG. 1 THE PROPER ORDER TO INSTALL WATER TREATING EQUIPMENT

(Shows sequence* of equipment only – seldom, if ever, would all items be needed)

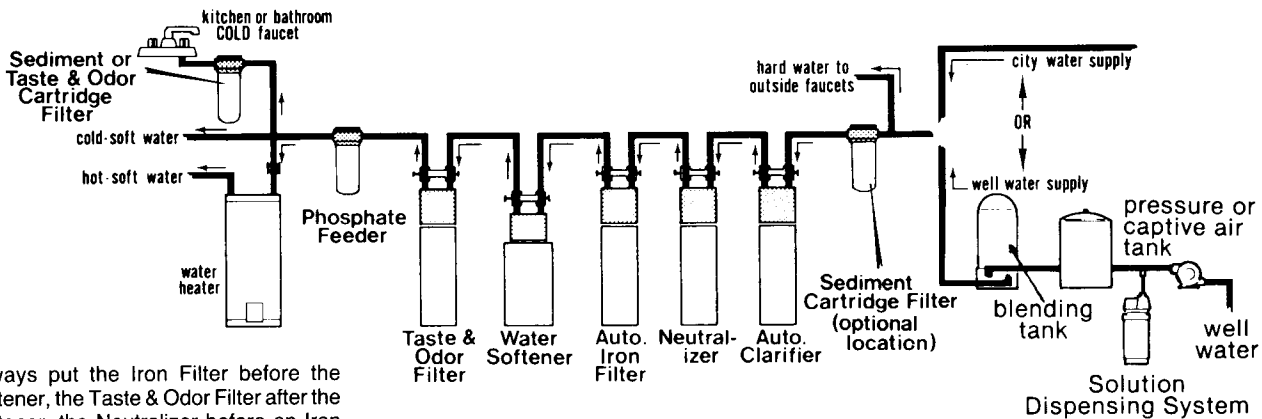

PLAN HOW TO INSTALL YOUR SOFTENER

You must first decide how to run in and out pipes to the softener. Look at your house main water pipe at the point you will connect the softener. Is the pipe soldered copper, glued plastic, or threaded galvanized or brass? What is the pipe size? What kind of pipe and fittings is it easiest for you to work with, and what

tools do you have?

Now look at the common plans for in and out piping on pages 8 and 9. Select the drawing best for you and use it as a guide to plan what materials you will need. As you plan your in and out piping, keep in mind the following check list. Then get all the materials you will need before you start.

SECTION 2

BEFORE YOU START TO INSTALL

TOOLS, PIPE, FITTINGS AND OTHER MATERIALS YOU WILL NEED

- ✓ In and out pipes to the softener must be at least 3/4 in. size. Some local codes may tell you to use no less than 1 in. pipe size (See Note on page 8 or 9).
- ✓ Use copper, brass, or galvanized pipe and fittings. Some codes may also allow CPVC plastic pipe.
- ✓ Copper and galvanized pipe corrode fast when connected together. Use pipe and fittings of the same material.
- ✓ You can buy adaptors to go from a copper or threaded main water pipe to CPVC in and out pipe.
- ✓ Sears has kits and bypass valves you can buy to help make installing your softener easier. See pages 8 and 9.
- ✓ ALWAYS install a bypass valve or valves. Either use 3 shut-off valves, or 1 of Sears special valves. Bypass valves let you turn off water to the softener, but still have water in the house pipes.
- ✓ Drain hose (7/16 in. inside diameter) is needed for valve and salt tank drains. See steps 9 and

10 on pages 12 and 13. You can buy flexible hose at most Sears stores

If a rigid valve drain is needed to comply with plumbing codes, you can buy the parts needed (See page 13) to change the softener to a 1/2 in. copper tubing drain.

- ✓ **TOOLS NEEDED:** — Common and cross point (Phillips) screw drivers, slip-joint pliers and a tape measure or rule. ALSO . . .

. . .for **SOLDERED COPPER** - tubing cutter, propane torch, solid-core **LEAD-FREE** solder, paste flux, emery cloth, sandpaper or steel wool.

. . .for **THREADED PIPE** - hacksaw or pipe cutter, pipe wrenches, pipe threading tool, pipe joint compound approved for use on potable water.

. . .for **CPVC PLASTIC** - hacksaw, adjustable wrench, solvent cement approved for use on potable water, primer.

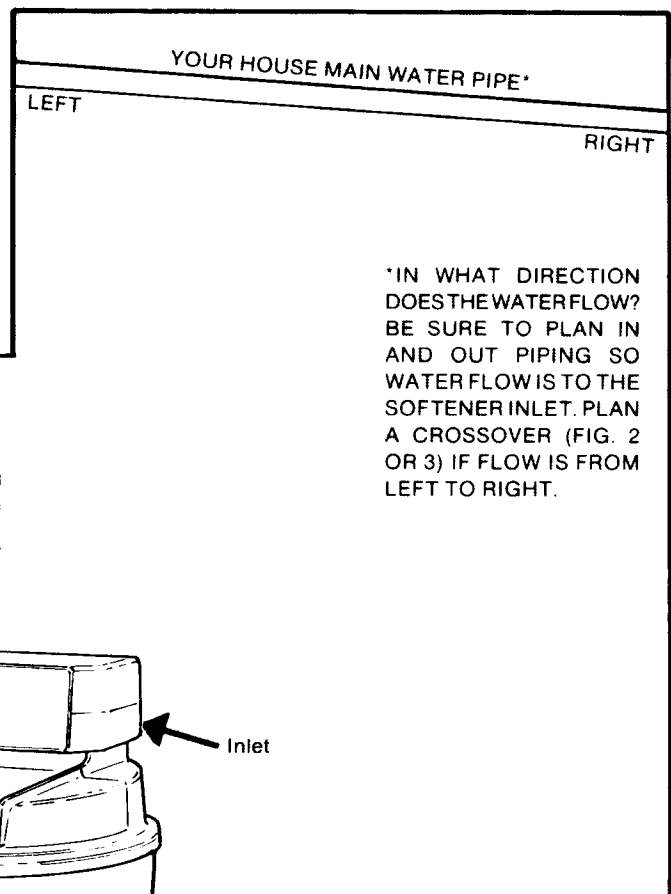

DRAW THE PLANS FOR YOUR IN AND OUT PIPING HERE. BE SURE TO FOLLOW GUIDES LISTED ABOVE. INCLUDE ALL PIPE, FITTINGS AND ACCESSORIES YOU WILL USE. MAKE A LIST OF ALL MATERIALS YOU NEED AND BUY THEM BEFORE YOU BEGIN TO INSTALL THE SOFTENER.

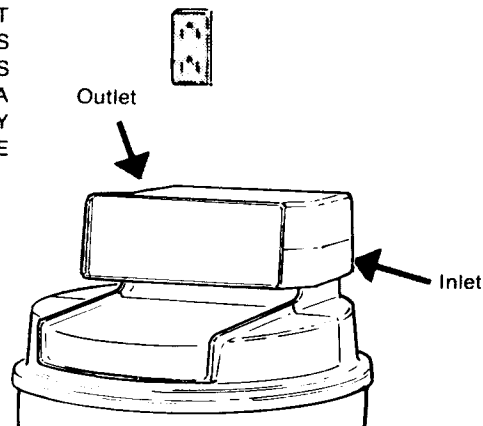

SECTION 2

PLANS FOR IN AND OUT PIPES TO SOFTENER

FIG. 2 SOLDERED COPPER (or CPVC)

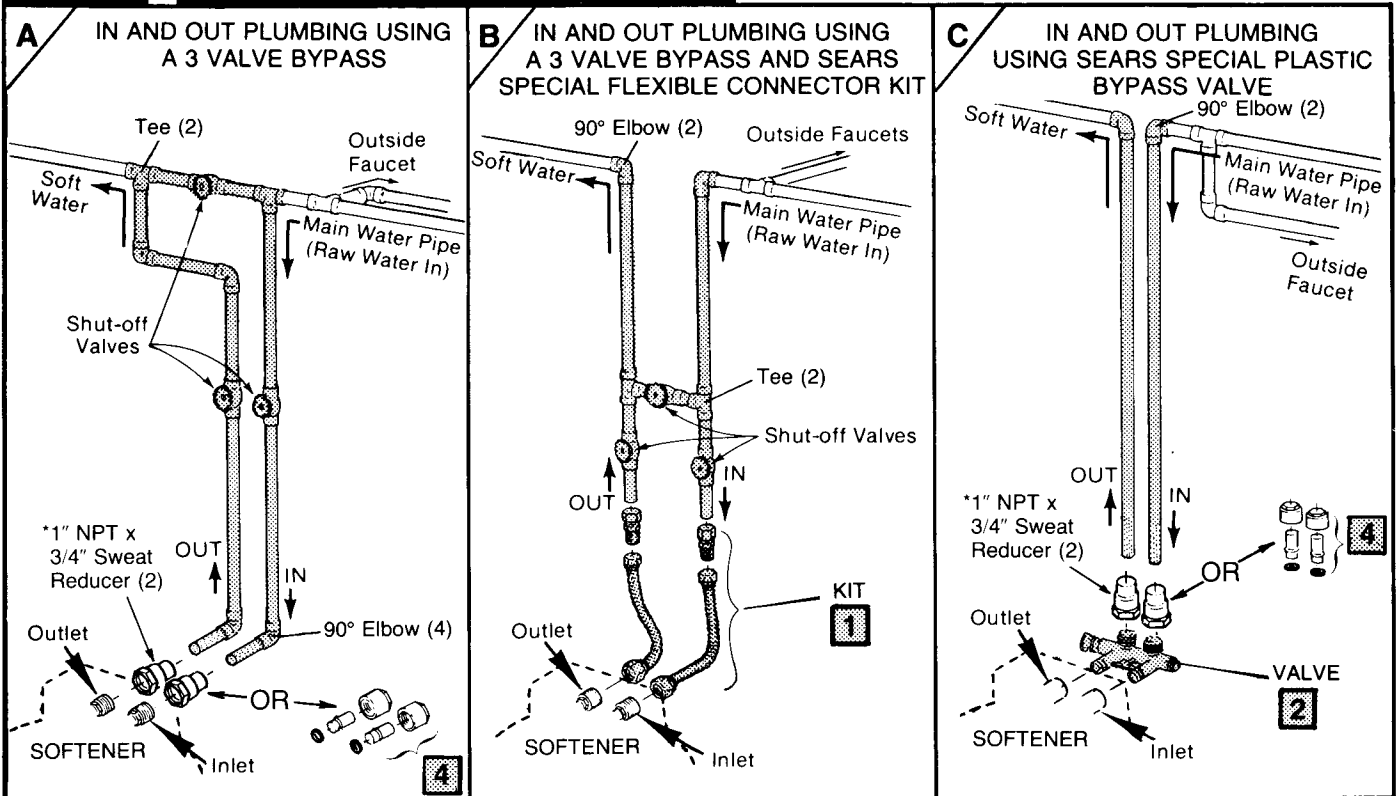

SEARS KITS AND VALVES TO MAKE INSTALLING YOUR SOFTENER EASIER

- 1** FLEXIBLE CONNECTORS
 Sears Item No. 42-3440
 Allows easy hook up even if pipes are not exactly aligned.
- 2** BYPASS VALVE (Plastic)
 Sears Item No. 42-3437
 One, easy working valve takes the place of 3 separate valves.
- 3** BYPASS VALVE (Brass)
 Sears Item No. 42-3436
- 4** INSTALLATION KIT
 Sears Item No. 42-3441

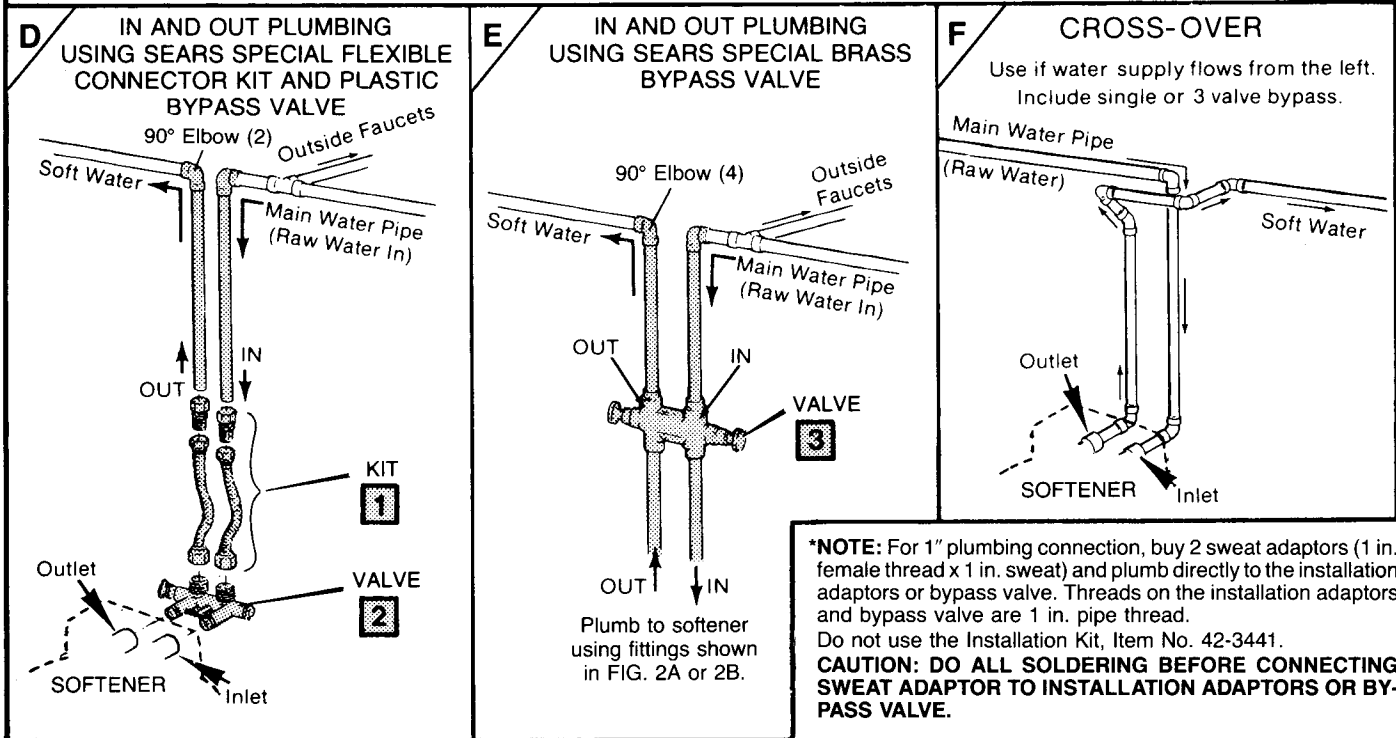

***NOTE:** For 1" plumbing connection, buy 2 sweat adaptors (1 in. female thread x 1 in. sweat) and plumb directly to the installation adaptors or bypass valve. Threads on the installation adaptors and bypass valve are 1 in. pipe thread. Do not use the Installation Kit, Item No. 42-3441.
CAUTION: DO ALL SOLDERING BEFORE CONNECTING SWEAT ADAPTOR TO INSTALLATION ADAPTOR OR BYPASS VALVE.

SECTION 2

PLANS FOR IN AND OUT PIPES TO SOFTENER

FIG. 3 **THREADED PIPE — GALVANIZED OR BRASS**

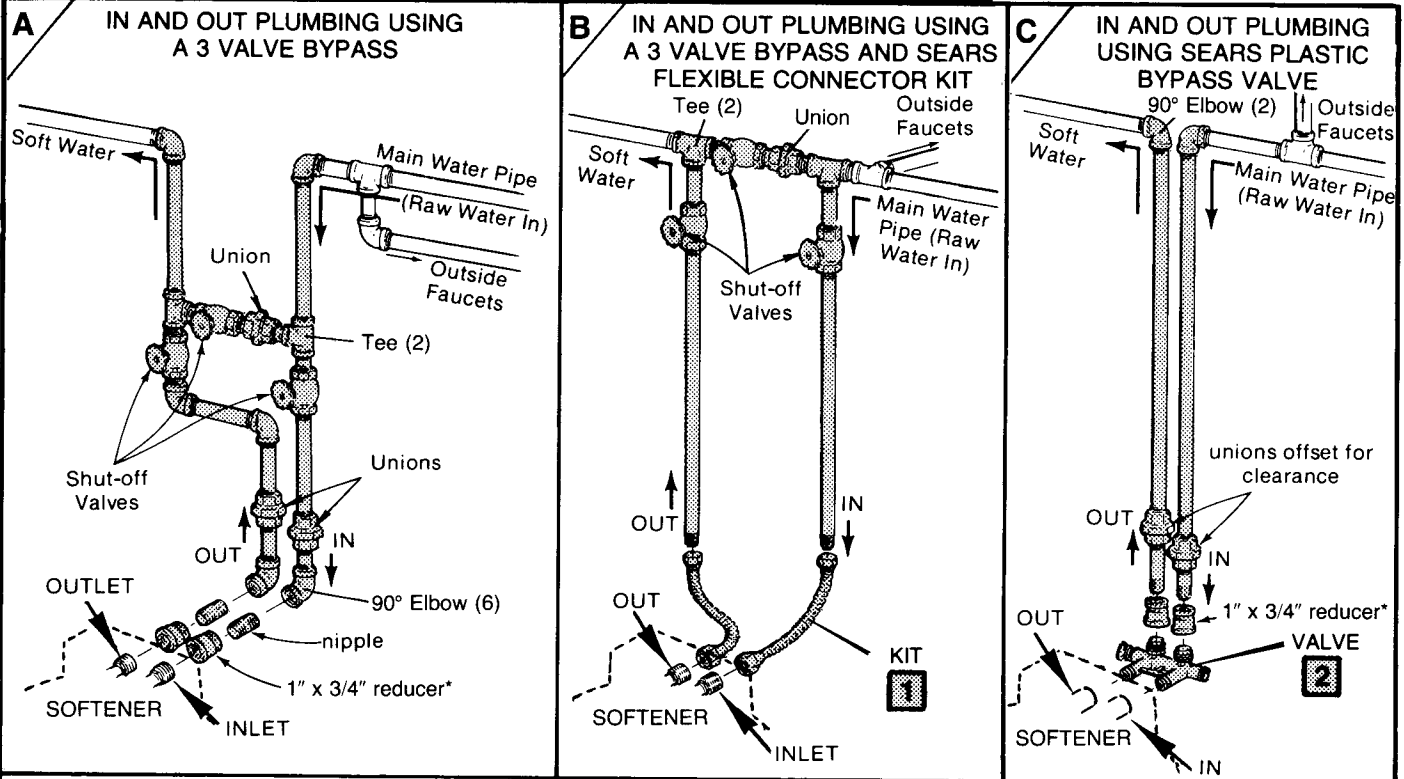

SEARS KITS AND VALVES TO MAKE INSTALLING YOUR SOFTENER EASIER

1 FLEXIBLE CONNECTORS
 Item No. 423440

Allows easy hook up, even if pipes are not exactly aligned.

2 BYPASS VALVE (Plastic)
 Sears Item No. 42-3437

One, easy working valve takes the place of 3 separate valves.

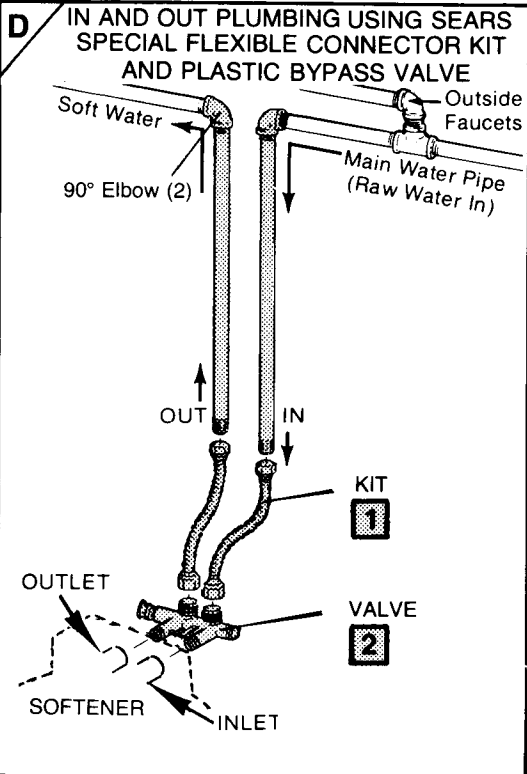

***NOTE:** For 1 in. plumbing connection, use a 1 in. threaded straight connector.

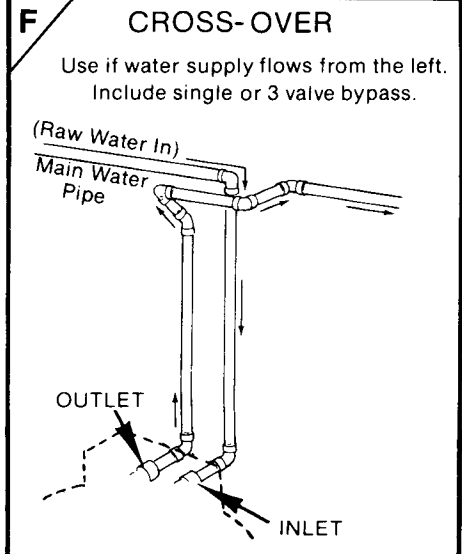

SECTION 3

STEP BY STEP GUIDES TO INSTALL

- ▲ 1. Close the shut-off valve on the house main water pipe, near the water meter or pressure tank, to turn off the water.

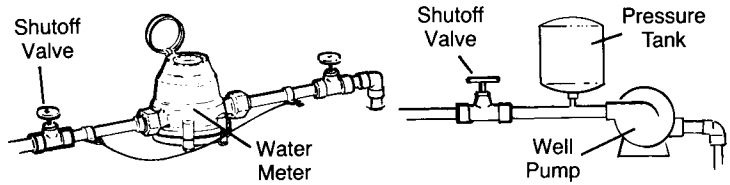

- ▲ 2. Shut off the gas or electric supply to the water heater.

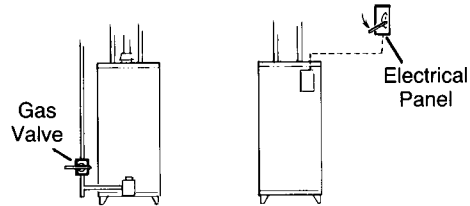

- ▲ 3. Open the highest and lowest water faucets in your house to let water drain from the pipes. Close faucets after water has drained.

- 4. If not already done, remove all cardboard or plastic packing pieces from inside the softener. Set the cardboard liner (with parts for installing fastened to it) where you can easily see it, and get to parts as you need them.

FIG. 4 INSTALLING INLET - OUTLET ADAPTORS OR BYPASS VALVE

5. INSTALL THE INLET AND OUTLET ADAPTORS OR SEARS BYPASS VALVE, STOCK NO. 42-3437.

NOTE: If you will install the bypass valve (use following steps a and c), the adaptors are not used. If you do not install the bypass valve, you must use the adaptors (use following steps a and b).

- a. Visually check and remove any foreign materials from the valve inlet and outlet ports (FIG. 4).

- b. **INLET AND OUTLET ADAPTORS** (Adaptors and clips are on the cardboard liner.) - Push the adaptors into the valve inlet and outlet ports (FIG. 4) as far as they will go (FIG 5). Both adaptors are the same and fit either valve port. **SNAP THE 2 LARGE HOLDING CLIPS INTO PLACE, FROM THE TOP DOWN AS SHOWN. BE SURE THEY SNAP FIRMLY INTO PLACE, SO THE ADAPTORS WILL NOT PULL OUT. . .GO TO STEP 6.**

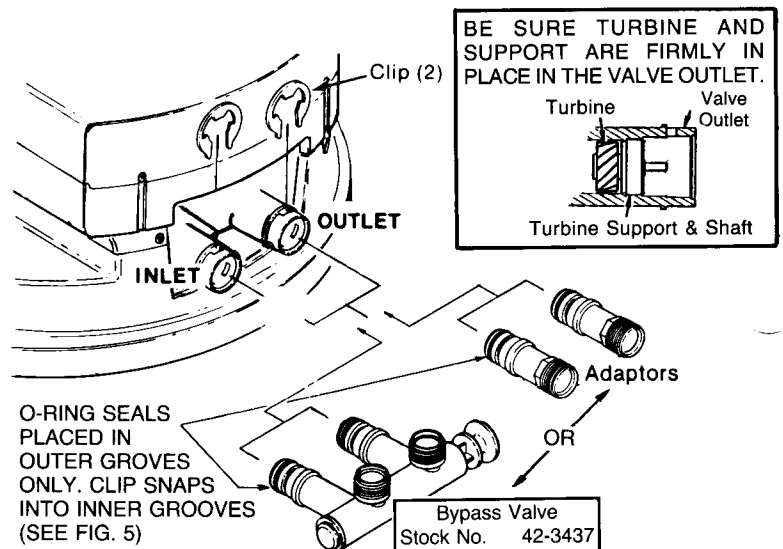
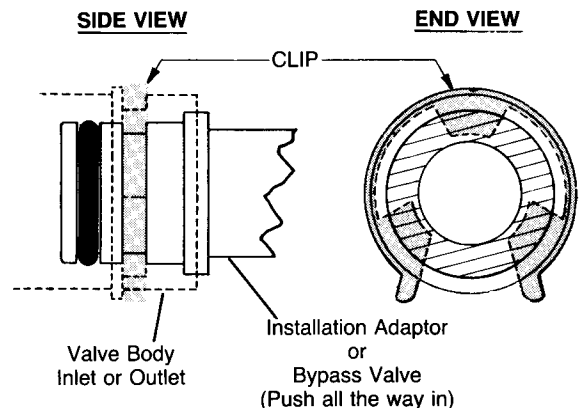

FIG. 5



SECTION 3

STEP BY STEP GUIDES TO INSTALL

- C. BYPASS VALVE, STOCK NO. 42-3437**
— If not already done, put a light coating of silicone grease or Vaseline on the bypass valve o-rings.

Push the bypass valve into the softener valve as far as it will go (FIG. 4, 5 and 6). **SNAP THE 2 LARGE HOLDING CLIPS INTO PLACE, FROM THE TOP DOWN AS SHOWN. BE SURE THEY SNAP FIRMLY IN PLACE, SO THE BYPASS VALVE WILL NOT PULL OUT. GO TO STEP 7.**

FIG. 6 BYPASS VALVE TURNED DOWNWARD

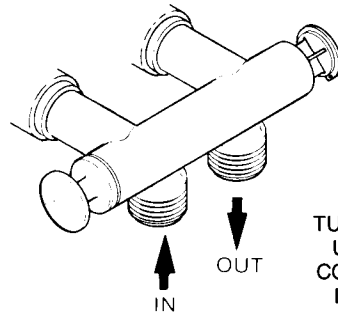

TURN BYPASS VALVE UPSIDE DOWN TO CONNECT TO FLOOR LEVEL PLUMBING

6. INSTALLING 3 VALVE BYPASS, OR SEARS BYPASS VALVE, STOCK NO. 42-3436, AND PIPES (FIG. 7)

- a.** Cut the house main water pipe where you will connect the softener. Loosely put together pipe, fittings, and the 3 valves or Sears special bypass valve. Place valve(s) within easy reach.

IMPORTANT: WHEN LOOKING AT THE FRONT OF THE SOFTENER, THE INLET IS ON THE RIGHT SIDE. IF WATER IN YOUR HOUSE MAIN WATER PIPE RUNS FROM LEFT TO RIGHT, BE SURE TO USE A "CROSS-OVER" AS SHOWN IN FIG. 2F OR 3F, PAGES 8 AND 9.

- b.** If all pipe, fittings and valves fit together good, tighten all threaded joints (use pipe dope on outside threads), or solder following tips on page 26.

FIG. 7 BYPASS VALVES

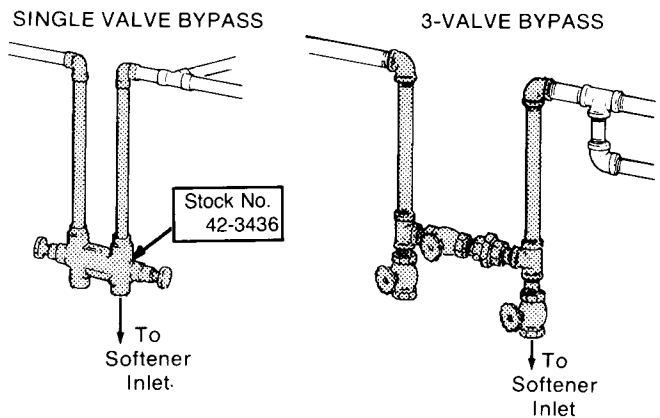

7. MOVE SOFTENER INTO PLACE

- 7.** Move the softener into place. Be sure the surface it sits on is level and smooth. If needed, put a piece of 3/4" plywood, at least 18" square, under the tank. Then put a spacer under the plywood to level the softener. **DO NOT PUT SHIMS OR SPACERS DIRECTLY UNDER THE TANK, WITHOUT THE PLYWOOD. THE WEIGHT OF THE SOFTENER, WHEN FULL OF SALT AND WATER, MAY CAUSE THE TANK TO PUNCTURE OR BREAK AT THE SHIM OR SPACER.**

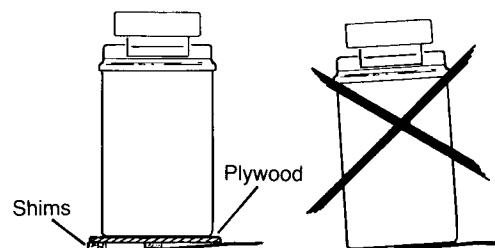

SECTION 3

STEP BY STEP GUIDES TO INSTALL

- 8. CONNECT THE SOFTENER** (Refer to your plan drawing on page 7, and to page 8 or 9.) Read the IMPORTANT note in step 6. Then, measure, cut (thread if needed) and put all pipe and fittings together up to the main water pipe, or to the bypass valve(s) you installed in Step 6.

NOTES:

- Include adaptors, reducers, union fittings, *flexible connectors, installation kit, etc., as needed.
- Cut pipe lengths exact for correct aligning, and to prevent stress on the softener valve.
- Use pipe joint compound or Teflon tape on outside pipe threads.
- When all piping fits together. . .
 - . . .solder all sweat fittings following tips on page 26.
 - . . .prime and cement all CPVC joints.
 - . . .tighten all threaded joints.

CAUTIONS:

- ▲ NEVER SOLDER FITTINGS WHILE CONNECTED TO NON-METALLIC PARTS. WAIT UNTIL SOLDERED PIPE HAS COOLED BEFORE CONNECTION (SEE FIG. 8).

FIG. 8 TYPICAL SOLDERING CONNECTION

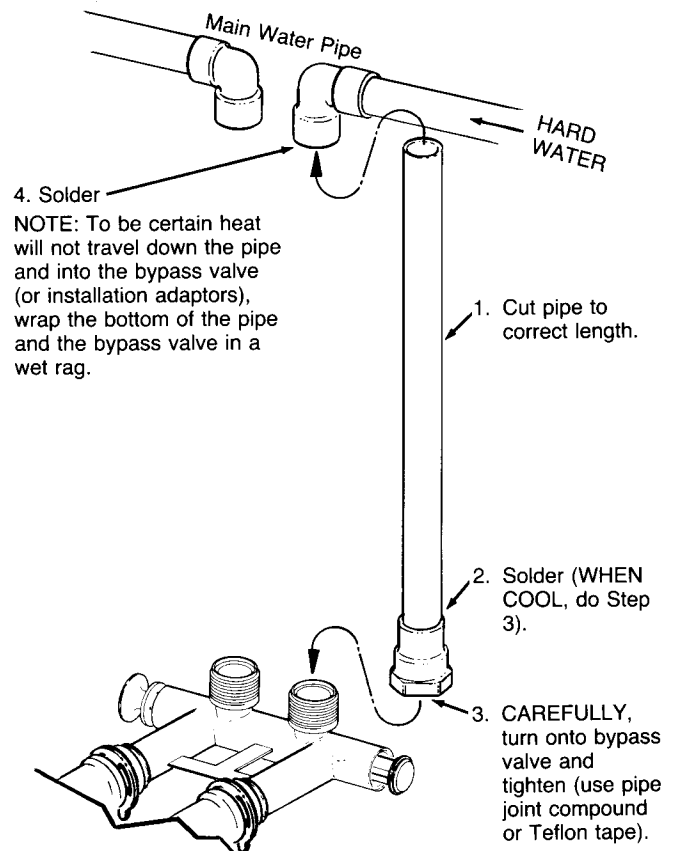

- ▲ CAUTION: BE VERY CAREFUL WHEN PUTTING PIPE FITTINGS ONTO THE PLASTIC THREADS OF THE SOFTENER ADAPTORS, OR THE BYPASS VALVE. DO NOT CROSSTHREAD. DO NOT OVERTIGHTEN.

*Flexible connectors are not allowed in all areas. CHECK YOUR LOCAL CODES.

- 9. CONNECT THE VALVE DRAIN HOSE**
- Take a length of 7/16" inside diameter (I.D.) drain hose and attach 1 end to the drain fitting (FIG. 9). Use a hose clamp to hold it in place. Put the other end of the hose over a floor drain, into a laundry tub, sump, standpipe, or other suitable drain. CHECK YOUR LOCAL CODES.

IMPORTANT NOTES: (see FIG. 9)

- ▲ Leave an air gap of about 1-1/2" between the end of the hose and the drain. This gap is needed so you don't get a back-flow of sewer water into the softener. DO NOT put the end of the hose into the drain or connect without the air gap.
- ▲ Place and support the hose so it does not kink or have sharp bends. Tie or wire the hose in place so water pressure will not make it "whip". Do not pinch the hose shut. THE SOFTENER WILL NOT WORK IF THIS DRAIN HOSE IS PINCHED, PLUGGED OR CLOSED IN ANY WAY.
- ▲ Keep the hose lower than the drain fitting. (In some homes, to get to a drain you must raise the hose and run it over-head. If you need an over-head drain, do not raise the hose more than 8' above the floor. A copper drain tube is best to use. . .see page 13.)

SECTION 3

STEP BY STEP GUIDES TO INSTALL

FIG. 9 DRAIN HOSES

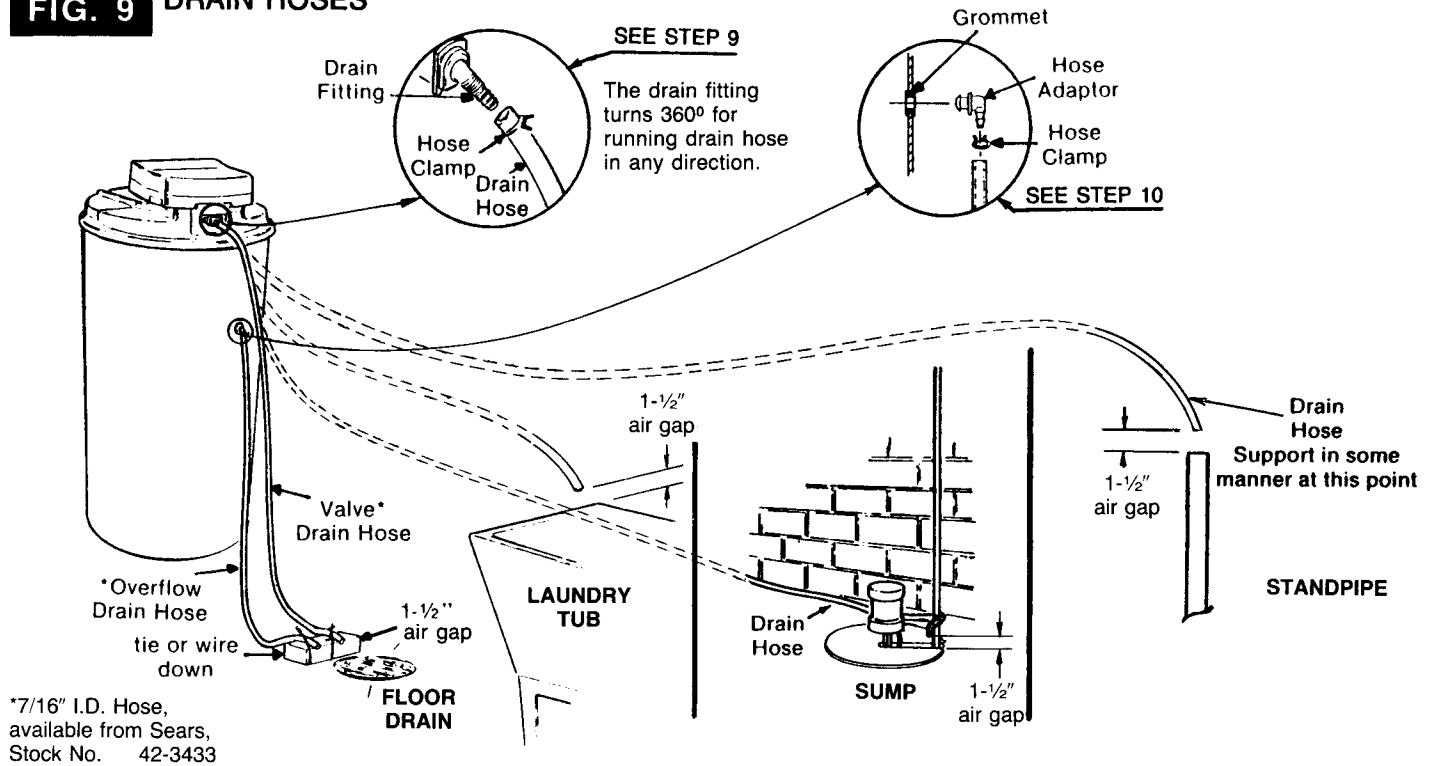

*7/16" I.D. Hose,
available from Sears,
Stock No. 42-3433

COPPER DRAIN TUBE: The plumbing codes where you live may say that you must use a copper valve drain tube. A copper tube is also best to use for an over-head drain. Use a copper drain tube if the softener is installed outside, or in the sunlight. Heat from the sun makes many kinds of rubber or plastic hose to soften and close up.

To adapt a copper drain tube to the softener, use a hacksaw to cut the barbed end from the drain fitting as FIG. 10 shows. Buy a compression fitting (1/4 in. female pipe threads x 1/2 in. O.D. tube) and tube from Sears, or your local hardware store.

FIG. 10 COPPER DRAIN TUBE

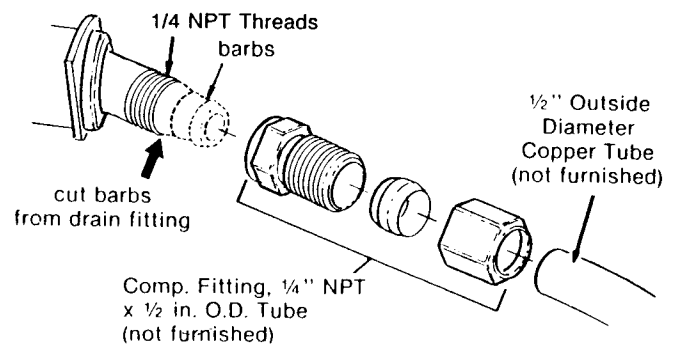

10. CONNECT A SALT TANK OVERFLOW HOSE

- Take the rubber grommet, hose adaptor and hose clamp (FIG. 9) that are on the small parts cardboard liner.
- Push the grommet into the hole in the salt tank wall so half is inside and half is outside.
- Push the bigger end of the hose adaptor into the grommet.
- Push one end of a length of 7/16" I.D. hose on to the hose adaptor, using the hose clamp to

hold it in place. Put the other end of the hose over the floor drain.

IMPORTANT NOTES:

- The salt tank overflow is for safety only. If the salt tank should overflow with water, the overflow hose carries it to the drain.
- Over-fill water must run downward through the hose. Do not raise the hose higher than the grommet and hose adaptor (FIG. 9).
- DO NOT connect to the valve drain hose you installed in step 9. A separate hose is needed for both drains.

SECTION 3

STEP BY STEP GUIDES TO INSTALL

11. TESTING YOUR PLUMBING WORK FOR WATER LEAKS.

Look at the picture in FIG. 12 showing your kind of bypass valve(s). On a single valve, slide the stem into SERVICE. On a 3-valve system, open the inlet and outlet valves and close the bypass valve.

- OPEN A HOT AND COLD WATER FAUCET TO LET AIR OUT OF THE SOFTENER AND HOUSE PIPES.
- Fully open the shut-off valve in the house main water pipe to turn on the water.

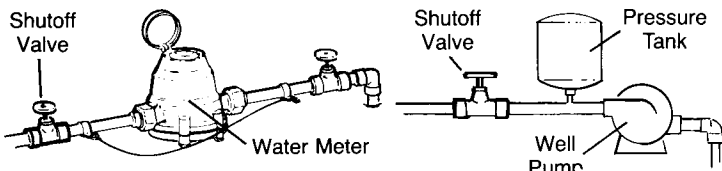

- After water from the faucets runs smoothly, with no more air bubbles, close them.
- Check your plumbing work for leaks and fix right away if any are found. READ THE CAUTION NOTES IN STEP 8 PAGE 12.

FIG. 12 BYPASS VALVES

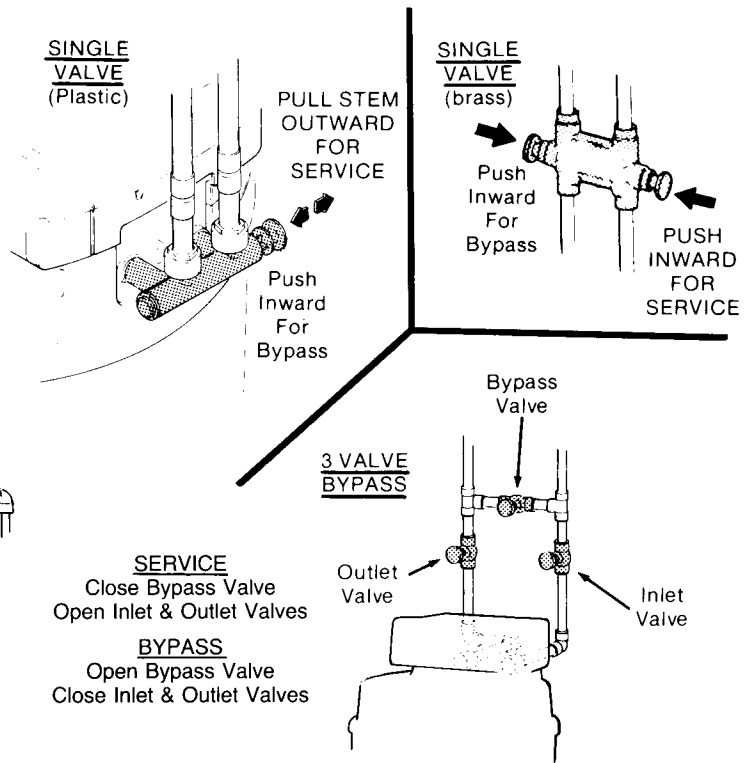

12. INSTALL GROUNDING WIRE BETWEEN THE SOFTENER IN AND OUT PIPES

The house cold water pipe (iron or copper) is often used to ground all electric outlets in the home. Outlets are grounded to protect you from shock when you touch any electric appliance plugged into the outlet. If you didn't install a 3-valve bypass, or a brass single bypass valve (FIG. 12), the cold water pipe ground is broken.

To restore the ground, take the clamps (2), screws (2), nuts (2) and ground wire that are on the card-

FIG. 13 COLD WATER PIPE GROUND

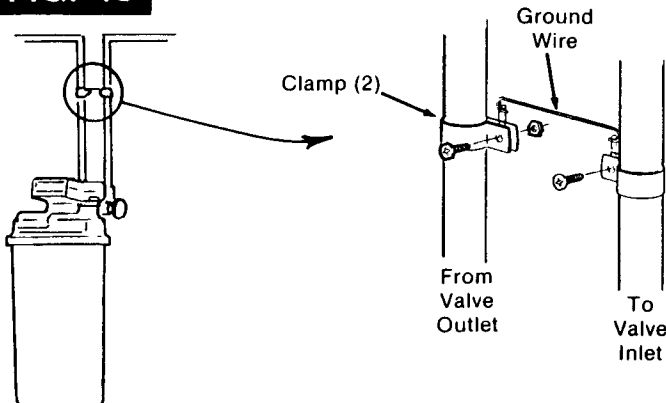

board liner. Install across the iron or copper in and out pipes as shown in FIG. 13. Be sure good contact is made between the pipe and the clamps. Fasten the ground wire tightly between the clamps.

IMPORTANT: Be sure the cold water pipe has direct metal to metal contact all the way to the ground. Plastic, rubber or other electrically insulating parts such as hoses, fittings, washers or gaskets can break the direct metal to metal contact. Also check the water meter (city water) or the well pump. Install #4 copper jumper wires, clamped tightly on both ends, across insulated parts (FIG. 14).

FIG. 14 WATER METER JUMPER WIRE

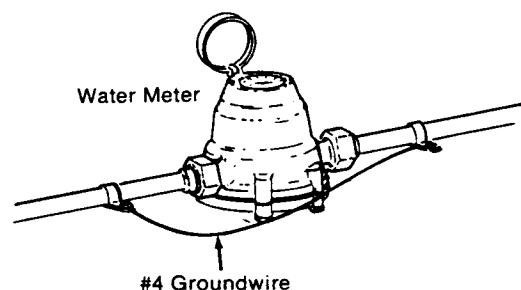

13. ELECTRIC POWER OUTLET FOR YOUR SOFTENER

The softener works on 24 volt, 60 Hz electric power. The included transformer changes standard 120 volt AC house power to 24 volts. You must plug the transformer into a 120 volt outlet only. Be sure the outlet is always "live" so someone cannot turn it off by mistake.

NOTE: The included transformer is made for inside use only. Be sure the electrical outlet you plug the transformer into is inside, to protect from weather (see page 6).

14. FASTEN THE POWER CABLE AND PLUG IN THE TRANSFORMER

Looking at FIG. 16, fasten the 2 power cable lugs (1 under each screw) to the transformer as shown. Tighten both screws. Then plug the transformer into the electrical outlet.

When the transformer is plugged in, the model code SR21 shows in the face plate display for a few seconds, followed by a test number (example: 1.0). After the test number, 12:00 AM begins to flash. PRESENT TIME and RECHARGE TONIGHT show at the bottom of the display.

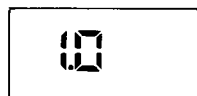
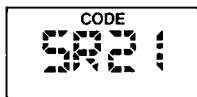

NOTE: If SR- flashes in the display, press the UP (▲) button (FIG. 18, page 16) until SR21 does show. Then press the SELECT button to display the flashing 12:00 AM. IF OTHER THAN SR21 SHOWS, WHEN THE TRANSFORMER IS PLUGGED IN, PLEASE SEE PAGE 24 TO RESET.

FIG. 16 CONNECTING TRANSFORMER

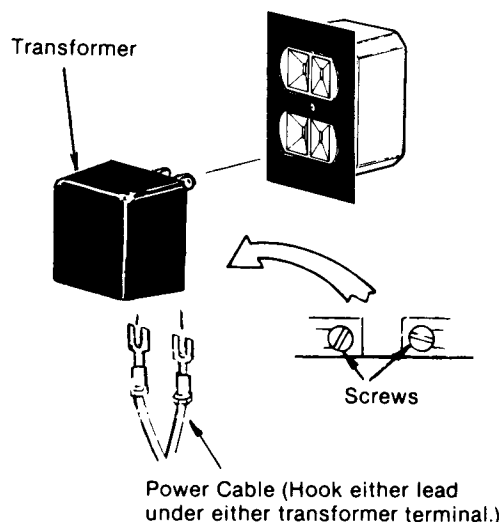

15. CHECK LIST OF STEP BY STEP GUIDES

To be sure you have done all the steps to install the softener, read the following list:

- ✓ Is the house water flow going INTO the softener valve INLET? Trace piping to be sure. (steps 6 and 8)
- ✓ Is the plumbing bypass valve (or 3 valves) set for SERVICE? (step 11)
- ✓ Is the valve drain hose connected the right way, and without sharp bends or kinks that could stop or reduce water flow? (step 9)
- ✓ Is the softener power cable connected to the transformer. . .and is the transformer plugged into an inside, 120V-60Hz electrical outlet? (steps 13 and 14)
- ✓ Be sure to restart the water heater. . .step 16.

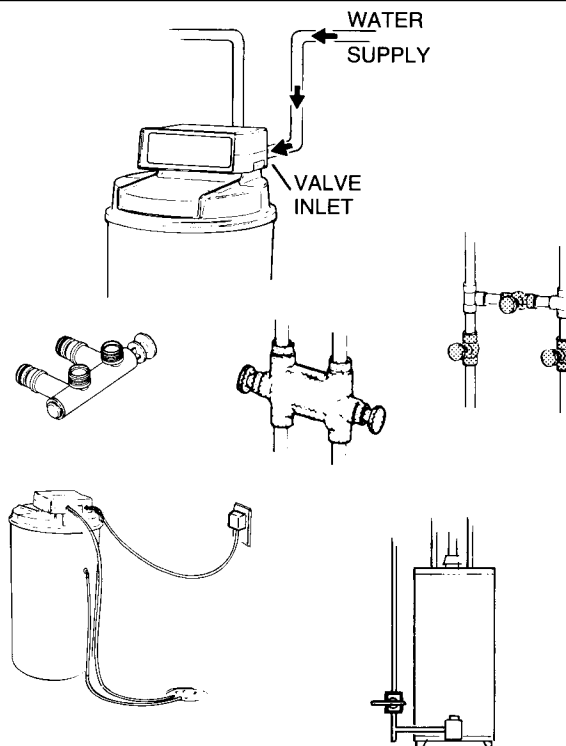

SECTION 3

STEP BY STEP GUIDES TO INSTALL

16. TURN ON THE GAS (OR ELECTRIC) SUPPLY TO THE WATER HEATER AND LIGHT THE PILOT.

NOTE: Your **WATER HEATER** is filled with **hard water**. To have fully soft water right away, you can drain the water heater so it refills with soft water. If you don't drain it, it will take a few days before you have fully soft water.

To drain the water heater, open a hot water faucet and let it run until the water turns cold. Then close the faucet.

GO TO SECTION 4, "SOFTENER START-UP".

SECTION 4

WATER SOFTENER START-UP

SANITIZE THE SOFTENER, SET THE TIMER, AND FILL WITH SALT TO COMPLETE INSTALLATION.

SANITIZING THE WATER SOFTENER

1. Care is taken at the factory to keep your water softener clean and sanitary. Materials used to make the softener will not infect or contaminate your water supply, and will not cause bacteria to form or grow. However, during shipping, storage, installing and operating, bacteria could get into the softener. For this reason, sanitizing as follows is suggested[Ⓛ] when installing.

- Use a pail or hose to fill the salt storage tank with at least 3 gallons of water.
- Remove the brinewell cover (FIG. 17) and pour about $\frac{3}{4}$ ounce of common 5.25% household bleach (Clorox, Linco, BoPeep, White Sail, Eagle, etc.) into the softener brinewell.
- Do Timer Settings, step 2, then step 3 to complete the sanitizing.

[Ⓛ] Recommended by the Water Quality Association. On some water supplies, the water softener may need periodic disinfecting. Sanitize with or without salt in the storage tank.

FIG. 17 ADD WATER AND FILL STORAGE TANK WITH SALT

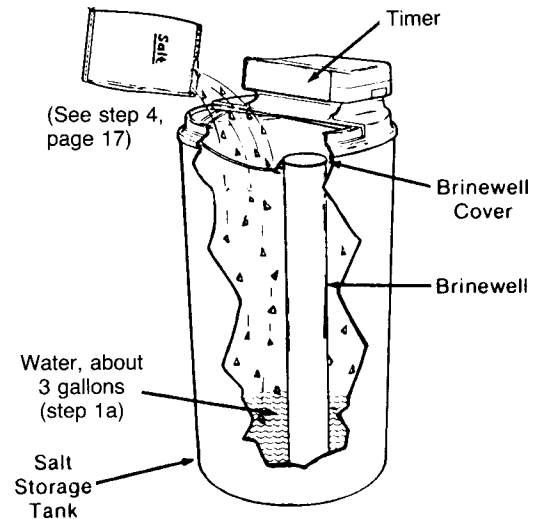

2. MAKE THE FACE PLATE TIMER SETTINGS

When you plugged the transformer in (page 15), time began to flash in the time display, beginning at 12:00 AM.



SOUND "BEEPER" — A "beeper" sounds while pressing buttons for timer set-up. One beep signals a change in the face plate display. Repeated beeps means the timer will not accept a change from the button you have pressed, telling you to use another button. For example, while setting the hardness below,

a. SET PRESENT TIME OF DAY:

Note: If the words PRESENT TIME do not show in the display, press the SELECT button (FIG.

FIG. 18

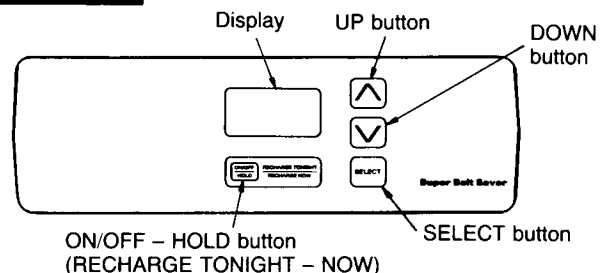

the beeper sounds repeatedly when the display reaches 1 using the DOWN button, or 95 using the UP button.

18) until they do.

■ Press the  UP/DOWN  buttons to set the

SECTION 4

WATER SOFTENER START-UP

present time. Press UP to move the display ahead; press DOWN to move the time backward.

If the present time is between noon and midnight, be sure PM shows.



If the present time is between midnight and noon, be sure AM shows.





NOTE: Each press of the UP/DOWN buttons changes the time by 1 minute. Holding the buttons in changes the time 32 minutes each second.

b. SET WATER HARDNESS NUMBER:

- Press the SELECT button once to display 15 (flashing) and HARDNESS.

The grains per gallon (gpg) hardness of your water supply is on your water analysis report (see page 5), or call and ask your local water department.



- Press the  UP/DOWN  buttons to set your water hardness number in the display. The DOWN button moves the display down to 1. The UP button moves the display up to 95.

NOTE: Each press of the UP/DOWN button changes the display by 1 between 1 and 25. Between 25 and 95, the display changes 5 at a time... 25, 30, 35 etc. Holding the UP/DOWN button in changes the display twice each second.



c. SET RECHARGE (REGENERATION) TIME:

- Press the SELECT button once to display 2:00 AM (flashing) and RE-CHARGE TIME.

At the 2:00 AM RECHARGE TIME setting, the softener begins regeneration (see pages 18 and 19) at 2:00 AM, ending no later than 4:00 AM. This is a good time in most households because water is not being used (see AUTOMATIC BYPASS, page 20).



If a different RECHARGE TIME setting would be better for your household, do the following.

- Press the  UP/DOWN  buttons to set the desired RECHARGE starting hour. Be sure to observe the AM-PM as you did when setting the present time of day.

NOTE: Each press of the UP/DOWN buttons changes the display 1 hour. Holding the buttons in changes the display twice each second.

- d. PRESS THE SELECT BUTTON ONCE AGAIN, to return the present time (steady) of day

and RECHARGE TONIGHT in the display.



3. Press the ON/OFF-HOLD button and hold for 3 seconds to start a recharge. This first recharge does several things.

- It draws the bleach (step 1) into and through the softener to sanitize it.

- It fills the salt tank to the water level needed.
- It gets all the air out of the resin tank.
- It makes the resin bed (see page 18) ready for service.

4. **FILL THE STORAGE TANK WITH SALT** Fill the tank with NUGGET or PELLET water softener salt. DO NOT use rock salts, (See page 22 and NOTE following). Before filling, BE SURE THE BRINEWELL COVER IS IN PLACE (FIG. 7). It takes about 230 lbs. of salt to fill the tank. Replace the salt storage tank cover after filling.

NOTE: WATER SOFTENING SALT WITH IRON REMOVING ADDITIVES — Some salts have an additive to help the softener handle iron in the water supply. Although this additive may help to keep the softener resin clean, it may also release corrosive fumes that will weaken and shorten the life of some softener parts.

SECTION 5

HOW YOUR WATER SOFTENER WORKS

OTHER FACE PLATE TIMER FEATURES

EXTRA RECHARGE

Sometimes, a manually started regeneration (re-charge) may be desired, or needed. Two examples are...

... You have used more water than usual (guests visiting) and you may run out of soft water before the next timer started regeneration.

... You did not refill the softener with salt before it was gone.

You can start a regeneration right away, or you can set the timer to regenerate at the next 2:00 AM (or other preset recharge time). Do the following.

RECHARGE NOW

- Press the ON/OFF-HOLD button and hold

for 3 seconds. RECHARGE NOW begins to flash in the display, and the softener enters the fill cycle of regeneration right away. This regeneration will last from 72 to 108 minutes, then you will have soft water again.



RECHARGE TONIGHT

- Press and release (DO NOT HOLD) the ON/OFF-HOLD button. RECHARGE TONIGHT flashes in the display, and the softener begins regeneration at the next preset recharge time. Press and release the ON/OFF-HOLD button once more if you decide to cancel the regeneration, and RECHARGE TONIGHT.



PROGRAM MEMORY

If electrical power to the softener goes off, the time display is blank but the face plate timer keeps the correct time for about 6 hours. When electrical power comes on again, you have to reset the present time **only** if the display is flashing. The HARDNESS and RECHARGE TIME never require resetting unless a

change is desired.

Even if the timer is incorrect after a long power outage, the softener works as it should to keep your water soft. However, regenerations may occur at the wrong time of day until you reset the timer to the correct time of day.

ERROR CODE

An error code could appear in the face plate display if a problem occurs in the softener electronics. If you see an error code in-

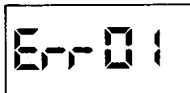

stead of the present time of day, please call your local Sears Service Department for service.

SOFT WATER SERVICE, AND REGENERATION

SERVICE

When the softener is giving you soft water, it is called "Service". During service, hard water comes from the house main water pipe into the softener. Inside the softener resin tank is a bed made up of thousands of tiny, plastic resin beads (FIG. 20). As hard water passes through the bed, each bead attracts and holds the hardness minerals. This is called ion-exchanging. It is much like a magnet attracting and holding metals. Water without the hardness minerals (soft water) flows out of the softener and into the house soft water pipes.

After a period of time, the resin beads become coated with hardness minerals and they have to be clean-

continued, next page

FIG. 20 WATER FLOW THROUGH THE SOFTENER IN SERVICE

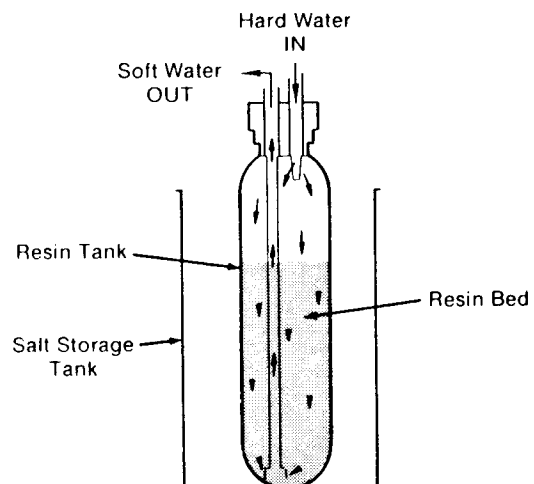

SECTION 5

HOW YOUR WATER SOFTENER WORKS

ed. This cleaning is called regeneration or recharge. Regeneration is started at 2:00 a.m. by the electronic timer (See page 17). It takes place in 5 stages or cycles. These are:

- 1 FILL
- 2 BRINING
- 3 BRINE RINSE
- 4 BACKWASH
- 5 FAST RINSE

REGENERATION

1 FILL: Salt, dissolved in water, is called brine. Brine is needed to clean the hardness minerals from the resin beads. To make the brine, water flows into the salt storage area during the fill stage as shown in FIG. 21. The fill cycle lasts from 9 to 21 minutes, depending on how much soft water making capacity you have used since the last regeneration. It fills longer, the more water you have used, and makes more brine. The greater amount of brine cleans more hardness minerals from the resin bed (see below).

2 BRINING: During brining, the brine is taken from the salt storage tank and put into the resin tank. Brine makes the resin beads let go of the hardness minerals and they are carried to the drain. How much brine is needed to clean the resin depends on 2 things—

- The amount of resin in the softener
- How fast the brine goes through the bed.

The nozzle and venturi (FIG. 22) make suction to take brine from the salt tank and put it into the resin tank. They keep the brine flow down to a very slow rate to get the best resin cleaning with the least salt.

3 BRINE RINSE: After all of the brine goes into the resin tank, the brine valve closes. Water keeps flowing the same way it did during brining except the brine flow has stopped. Hardness minerals and brine flush from the resin tank to the drain. Brining and brine rinse together vary in length, from 47 to 71 minutes, relative to fill cycle length.

FIG. 21 WATER FLOW THROUGH THE SOFTENER IN FILL

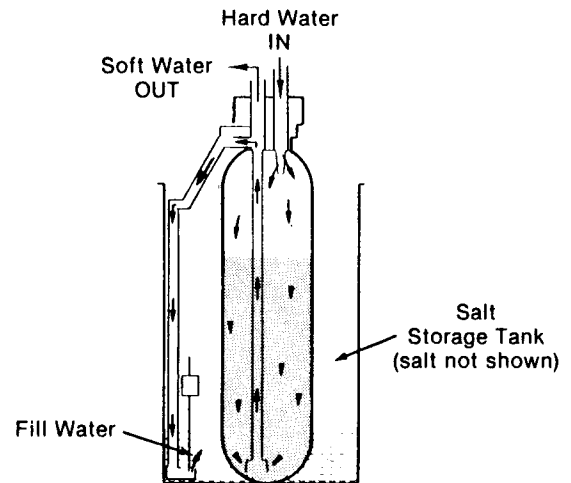
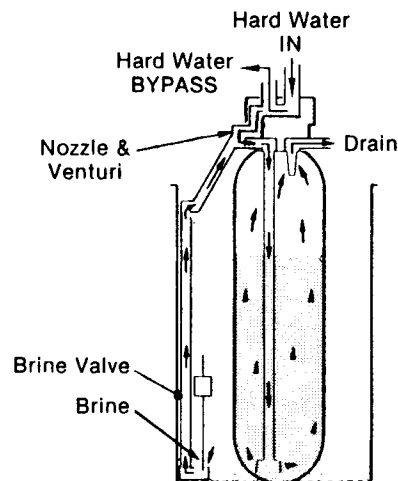

FIG. 22 WATER FLOW THROUGH THE SOFTENER IN BRINING AND BRINE RINSE



continued, next page

SECTION 5

HOW YOUR WATER SOFTENER WORKS

4 **BACKWASH:** During backwash, water flows UP through the resin tank (FIG. 23) at a fast rate to flush iron minerals, dirt and sediments from the bed and to the drain. The bed lifts and expands for good cleaning. The backwash cycle is about 7 minutes long.

FIG. 23 WATER FLOW THROUGH THE SOFTENER IN BACKWASH

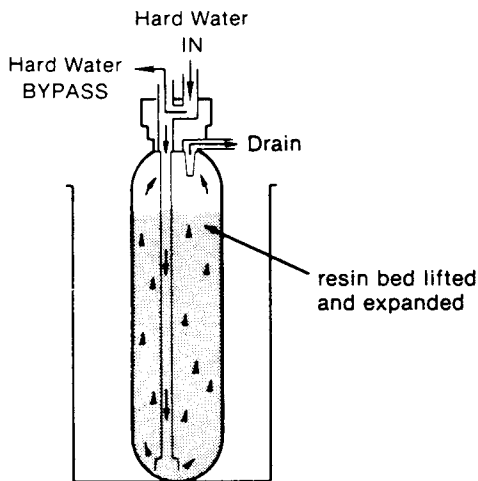

5 **FAST RINSE:** Backwash is followed by a fast flow of water, down through the resin tank. The fast flow packs the resin bed and gets it ready for return to service (FIG. 24). This cycle is about 3 minutes long.

After fast rinse, the softener returns to service. Hard water goes into the resin tank where the resin bed again takes out the hardness minerals. Soft water goes to the house soft water pipes.

FIG. 24 WATER FLOW THROUGH THE SOFTENER IN FAST RINSE

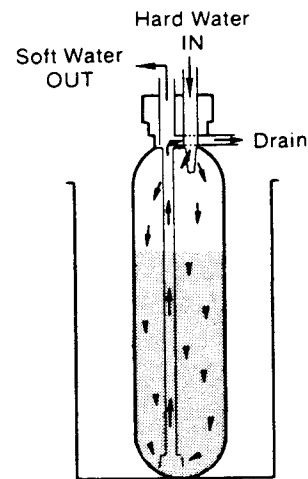

AUTOMATIC BYPASS

During the brining, brine rinse and backwash cycles of regeneration, HARD water goes through the softener valve and to the house pipes. If a faucet is opened, hard water is there for your needs. However, you should not use HOT water, if possible, because the water heater will refill with hard water. The softener regenerates from 2:00 AM to about

4:00 AM, (you can set anytime), a time when not much water is used.

If you get up early in the morning and you can hear the softener regenerating, change the time setting. Set the recharge time to 12:00 AM or 1:00 AM (page 17). Then regeneration will start and end that much earlier and your water heater will not refill with hard water if a hot faucet is opened.

ELECTRONICS

Two main parts of the softener's electronics are **1** a WATER METER, and **2** a COMPUTER.

1 **WATER METER** — The water meter is in the softener valve outlet. As water flows through the meter it sends electric pulses to the computer. The computer changes the pulses to a measure in gallons of water.

2 **COMPUTER** — the computer is part of the circuit board. It is programmed to know the softener's capacity (how many grains of hardness minerals it will take out of the water before a regeneration is needed). When starting the softener, page 17, you set it for the grains per gallon (GPG) hardness of the water.

continued, next page

SECTION 5

HOW YOUR WATER SOFTENER WORKS

The computer uses, (1) water usage from the meter, (2) hardness setting, (3) softener capacity, and (4) time since the last regeneration, to find a regeneration pattern best for your needs. The computer always adjusts this pattern to your water using habits. It works toward providing you with soft water for the longest time and the most efficient salt usage.

As hard water goes through the softener and hard-

ness minerals are removed, capacity is used. When the computer determines only enough capacity remains to provide soft water up to the next regeneration starting time (2:00 AM, or as otherwise set) it will schedule a regeneration. **RECHARGE TONIGHT** displays until the regeneration begins. When the regeneration begins, TONIGHT goes off and **RECHARGE NOW** flashes during the regeneration, which lasts between 72 and 108 minutes.

WIRING CONNECTION DIAGRAM

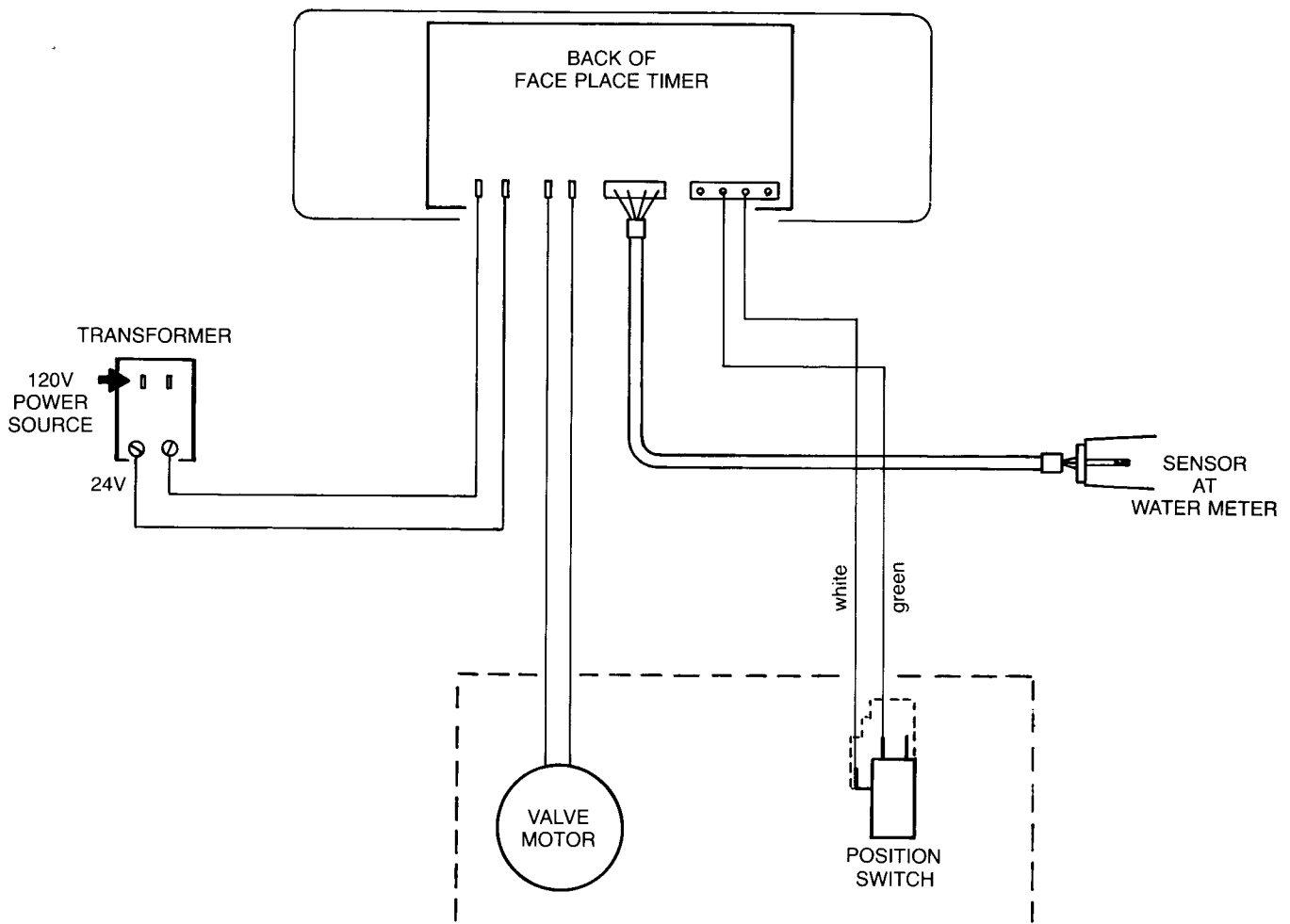

SECTION 6

CARE OF YOUR SOFTENER

CHECKING THE SALT STORAGE LEVEL AND REFILLING

Brine (salt dissolved in water) is needed for each and every regeneration. The water for making brine is metered into the salt storage tank by the softener. However, you must keep the tank filled with salt.

WHEN TO REFILL WITH SALT: Check the salt level a few weeks after you install the softener and every week after that. Refill when the storage tank is about half full. Never let the softener use all the salt before refilling. Without salt, you will soon have hard water.

Use nugget or pellet water softener salt only. Do not use rock salts. They have dirt and sediments that will make the softener stop working (also see page 16). **BE SURE THE BRINEWELL COVER IS IN PLACE.**

NOTE: YOU WILL HAVE A LOSS IN SOFTENING CAPACITY AND MAY GET PARTLY HARD WATER IF LESS THAN 10 INCHES OF SALT IS IN THE STORAGE TANK.

NOTE: WATER SOFTENING SALT WITH IRON REMOVING ADDITIVES — Some salts have an additive to help the softener handle iron in the water supply. Although this additive may help to keep the softener resin clean, it may also release corrosive fumes that will weaken and shorten the life of some softener parts.

FIG. 25

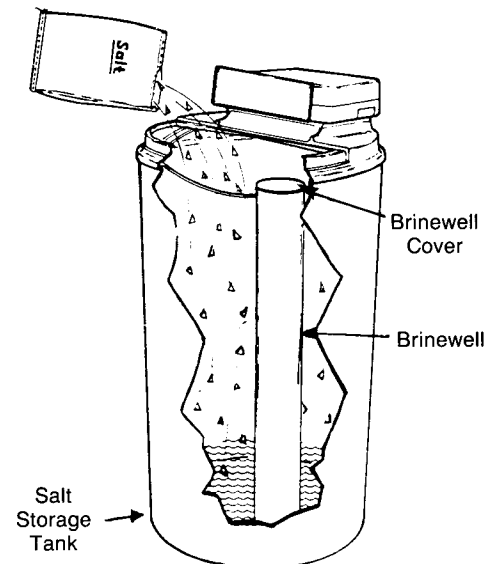

BREAKING A SALT BRIDGE

Sometimes, a hard crust or salt bridge forms in the salt storage tank. It is usually caused by high humidity or the wrong kind of salt. When the salt bridges, an empty space forms between the water and salt. Then salt will not dissolve (melt) in the water to make brine. Without brine, the resin bed does not regenerate and you will have hard water.

If the storage tank is full of salt, it is hard to tell if you have a salt bridge. Salt is loose on top, but the bridge is under it. The following is the best way to check for a salt bridge.

Salt should be loose all the way to the bottom of the tank. Your salt storage tank is about 41 in. high from the bottom to the top rim (FIG. 26). Take a broom handle, or like tool, and make a pencil mark 41 inches from one end. Carefully push it straight down into the salt. If a hard object is felt before the pencil mark gets to the top of the tank, it's most likely a salt bridge. Carefully push into the bridge in a few places

FIG. 26 A SALT BRIDGE

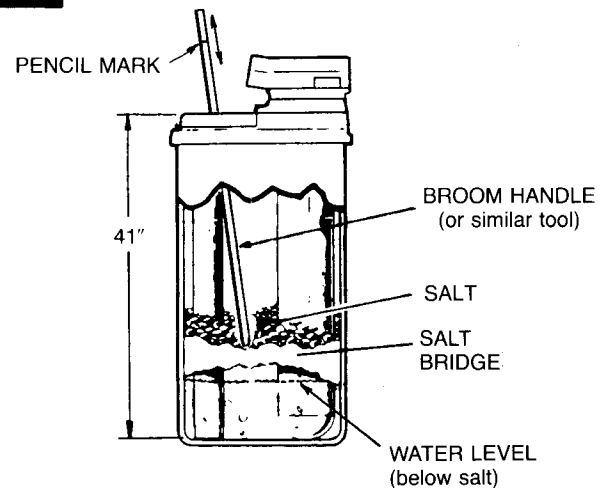

to break it. **DO NOT TRY TO BREAK THE SALT BRIDGE BY POUNDING ON THE OUTSIDE OF THE SALT TANK. YOU MAY DAMAGE IT.**

If the wrong kind of salt made the bridge, take it out. Then fill the tank with nugget or pellet salt only.

SECTION 6

CARE OF YOUR SOFTENER

CLEANING THE COVERS

To keep your new Sears water softener looking nice, apply a coat of paste wax and repeat once a year. When dusty, wipe it with a damp cloth to keep it sparkling.

- ▲ Never use cleaners having ammonia or abrasives. They may scratch and dull the surface.

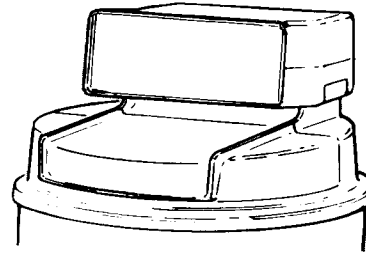

CLEANING THE NOZZLE & VENTURI

A clean nozzle and venturi (FIG. 27) is a must for the softener to work right. This small unit moves brine from the salt storage tank to the resin tank during regeneration. If it becomes plugged with sand, silt, dirt, etc., the softener will not work and you will get hard water.

To get to the nozzle and venturi, remove the softener top cover. Be sure the softener is in service cycle (no water pressure at nozzle and venturi), then turn off the cap from the nozzle and venturi housing. **DO NOT LOSE THE LARGE O-RING SEAL.** Lift out the screen support and screen, then the nozzle and venturi. Wash and rinse the parts in warm water until clean. If needed, use a small brush to remove iron or dirt. Also check and clean the gasket and flow plug if dirty.

Carefully replace all parts in the correct order. Lubricate the o-ring seal with silicone grease or Vaseline and place in position. Install and tighten the cap, **BY HAND ONLY. DO NOT OVERTIGHTEN AND BREAK THE CAP OR HOUSING.**

If you have to clean the nozzle & venturi quite often,

FIG. 27

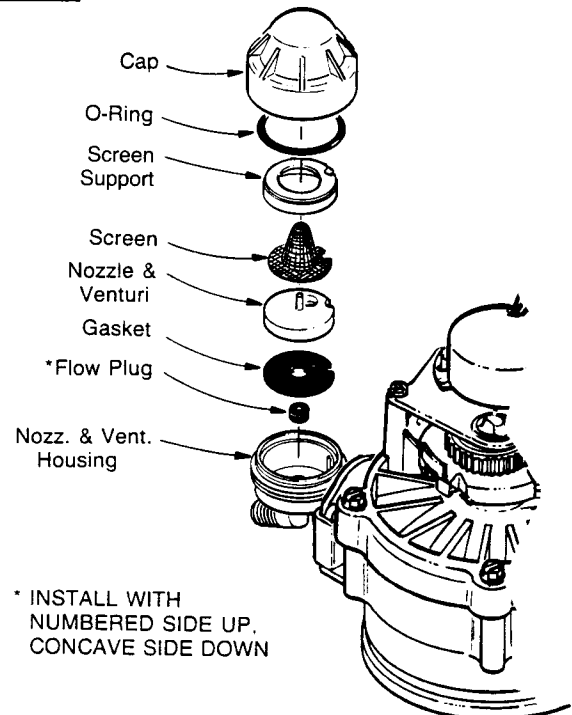

you may decide to install a Sears sediment cartridge filter (See FIG. 1, page 6). This filter takes dirt and sediments out of the water.

CLEANING IRON OUT OF THE SOFTENER

Your water softener takes hardness minerals (calcium and magnesium) out of the water. Also, it can control up to 3 parts per million (ppm) of "clear water" iron. With clear water iron, water from a faucet is clear when first put into a glass. After 15 to 30 minutes, the water begins to cloud or turn rust colored. A water softener **WILL NOT** remove any iron which makes the water cloudy or rusty as it comes from the faucet (called red water iron). To take red water iron out of water, or over 3 ppm of clear water

iron, an iron filter of other equipment is needed. Your local Sears store has trained people to help you with iron water problems.

If your water supply has clear water iron, even though less than 3 ppm, regular resin bed cleaning is needed. Sears has resin bed cleaner, Stock No. 42-34425 for this. Clean the bed at least every 6 months. If iron shows up in the soft water before 6 months, clean more often. Printed instructions are on the resin bed cleaner bottle.

SECTION 6

CARE OF YOUR SOFTENER

KEEP THE SOFTENER FROM FREEZING

If the softener is installed where it could freeze (summer cabin, lake home, etc.), you must drain all water from it to stop possible freeze damage. To drain the softener—

1. Close the shut-off valve on the house main water pipe, near the water meter or pressure tank.
2. Open a faucet in the soft water pipes to vent pressure in the softener.
3. Looking at FIG. 12 on page 14, move the stem in a single bypass valve to bypass. Close the inlet and outlet valve in a 3-valve bypass system, and open the bypass valve.

(If you want water in the house pipes again, reopen the shut-off valve on the main water pipe).

4. Unplug the transformer at the wall outlet. Take off both drain hoses.
5. Carefully remove the large holding clips at the softener inlet and outlet (See steps 5b and 5c, pages 10 and 11). Separate the softener from the adaptors or bypass valve.
6. Take off the salt tank and brinewell cover. Disconnect the brine valve tubing at the nozzle and venturi assembly (See page 30) and lift the brine

FIG. 28 DRAIN WATER FROM THE SOFTENER

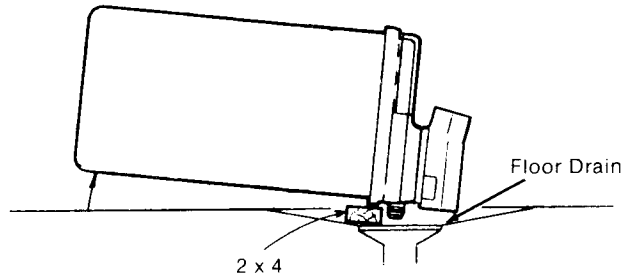

valve out of the brinewell. Tip the brine valve upside down to drain out water.

7. Looking at FIG. 28, lay a piece of 2 inch thick board near the floor drain. Move the softener close to the drain. SLOWLY and CAREFULLY tip it over until the rim rests on the wood block with the inlet and outlet over the drain. DO NOT ALLOW THE SOFTENER'S WEIGHT TO REST UPON THE INLET AND OUTLET FITTINGS OR THEY WILL BREAK.
8. Tip the bottom of the softener up a few inches and hold until all water has drained. Leave the softener laying like this until you are ready to use it. Plug the inlet and outlet with rags to keep dirt, bugs, etc. out.

HELPFUL HINTS CHECKLIST . . . TO HELP YOU SAVE MONEY

If your water softener fails to work, make the following easy checks. Often, you will find what's wrong yourself and you won't have to call and wait for service. If, after making the checks, your softener still does not work right, call your Sears Service Department.

NOTE: Also read ERROR CODE, page 18. If an error code is not displayed, press and hold the SELECT button until (example: 000- -) shows in the display. Then press SELECT again and hold until an SR code appears. It must show SR21. If SR16 or 39 shows, the softener computer is working on incorrect input and would probably be the cause of the problem. To set SR21, press either the UP or DOWN button. Then press SELECT to return a flashing 12:00 AM display, and reset the timer, pages 16 and 17.

NO SOFT WATER

- **NO SALT (OR SALT BRIDGED) IN THE STORAGE TANK** — Refill with salt, or break the salt bridge (page 22). Press the ON/OFF-HOLD (RECHARGE NOW) button and hold for 3 seconds to start a regeneration (see page 18).

continued, next page

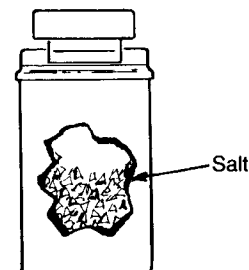

SECTION 6

CARE OF YOUR SOFTENER

- **TRANSFORMER UNPLUGGED AT THE WALL OUTLET, POWER CABLE LEADS LOOSE, FUSE BLOWN, CIRCUIT BREAKER POPPED, OR CIRCUIT SWITCHED OFF** — Check for loss of power due to any of these and correct. With the power back on, look at the time display and read PROGRAM MEMORY, page 18.

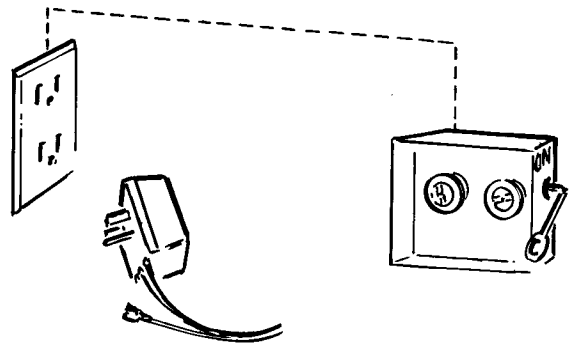

- **MANUAL BYPASS VALVE(S) IN BYPASS POSITION** — Look at FIG. 12 on page 14. Move the stem in a single valve to service. In a 3-valve bypass, open the inlet and outlet valves, and be sure to fully close the bypass valve.

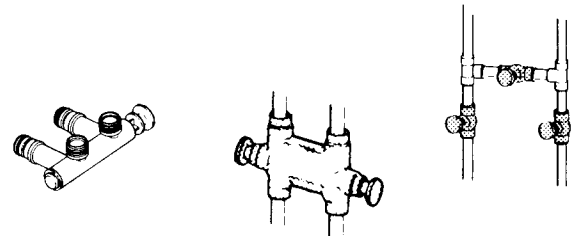

- **DIRTY, PLUGGED OR DAMAGED NOZZLE & VENTURI** — Take apart and clean or replace damaged parts (page 23).

- **VALVE DRAIN HOSE PLUGGED** — The drain hose must not have kinks, sharp bends, or be raised to high above the softener (See page 12).

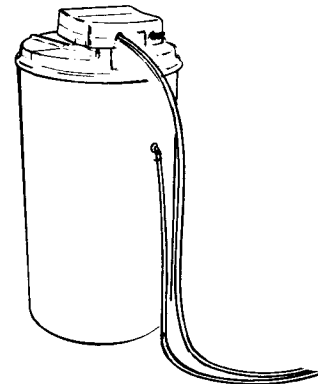

WATER HARD SOMETIMES

- **HARDNESS NUMBER SETTING TOO LOW** - Press and release the SELECT button until HARDNESS shows in the display. Read the hardness number in the display and be sure the same grains per gallon number is shown on your water analysis report. See page 17 to reset. Press and release the SELECT button until the present time shows in the display.



- **USING HOT WATER WHEN THE SOFTENER IS REGENERATING** — Avoid using hot water during this time because the water heater refills with hard water (See Automatic Bypass, page 20).

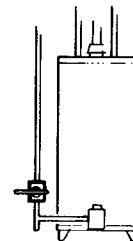

- **INCREASE IN THE GRAINS OF HARDNESS IN YOUR WATER SUPPLY** — Ask your Sears retail or catalog store for a new water analysis. Then make a new hardness number setting (page 17).

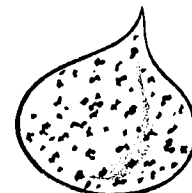

SWEAT SOLDERING TIPS

MEASURING PIPE LENGTHS: Always be sure to include the length of pipe that goes inside the fitting. On 3/4 in. pipe, this length is about 3/4 in.

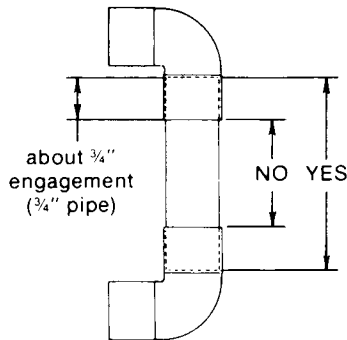

CUTTING PIPE: Turn the pipe cutter back and forth around the outside of the pipe. Tighten the pipe cutter slowly with each turn until all the way through the pipe. To keep from crushing or distorting the pipe, do not tighten the cutter too much at a time. File burrs from cut ends.

CLEAN PIPE AND FITTING SOLDERING SURFACES: With emery cloth, fine sandpaper or steel wool, clean the end of the pipe and inside of the fitting. Clean surfaces until they shine. Do not grind off too much material, making the fit too loose.

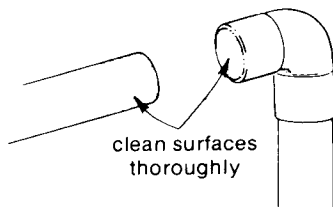

CHECK THE FIT: Push the pipe into the fitting as far as it will go. Use some force to slip together, but do not hammer or pound. If too tight, clean surfaces until fit is good.

PUT ON PASTE FLUX: Freely apply paste flux on both cleaned surfaces. Place pipe into the fitting and turn to spread the paste around.

BEFORE SOLDERING, READ THESE SAFETY GUIDES. (Also see Safety Guides, page 4.)

- ▲ Keep torch flame away from walls, the water softener, and other materials that will burn.
- ▲ Do not touch newly soldered pipe with your hands.

Wrap nearby, already soldered joints with a wet cloth so solder does not melt.

Let soldered joints cool slowly. Sudden cooling can crack or weaken the solder.

SOLDERING: Light the torch and set to a moderate flame. Move the flame over and around the joint to heat pipe and fitting. In a short time, touch the end of the solder wire to the lip of the fitting. **DO NOT PLACE SOLDER IN THE FLAME.** The solder will melt and draw into the connection when the pipe and fitting are at the right temperature. Run the solder around the lip until the joint is full. Do not overfill as solder will run into and harden inside the fitting. Being careful not to touch the pipe with your hands, make a quick swipe around the joint with a cloth to take off excess solder.

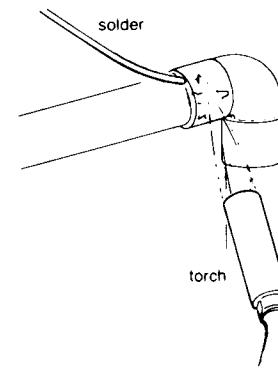

For a good sweat solder joint, the pipe and fitting must not have any water inside them. Water, when heated by the torch, weakens the solder and often the joint will leak. If you can not keep the inside of the pipe dry, wad up a piece of bread into a ball. After putting paste flux on both the pipe and fitting, place the bread wad into the pipe and poke in several inches. Put the pipe and fitting together and solder. The bread absorbs moisture while you are soldering. When the water is turned on, the bread dissolves and is flushed out an open faucet.

LEAKING CONNECTIONS: You can try to reheat and resolder a leaking joint, but it's usually best to start over. Turn off the water, reheat and take the pipe and fitting apart. Take off all old solder, cleaning down to the copper surface. Apply new paste flux and solder again.

SECTION 7 OTHER THINGS TO KNOW

SEARS WATER SOFTENER

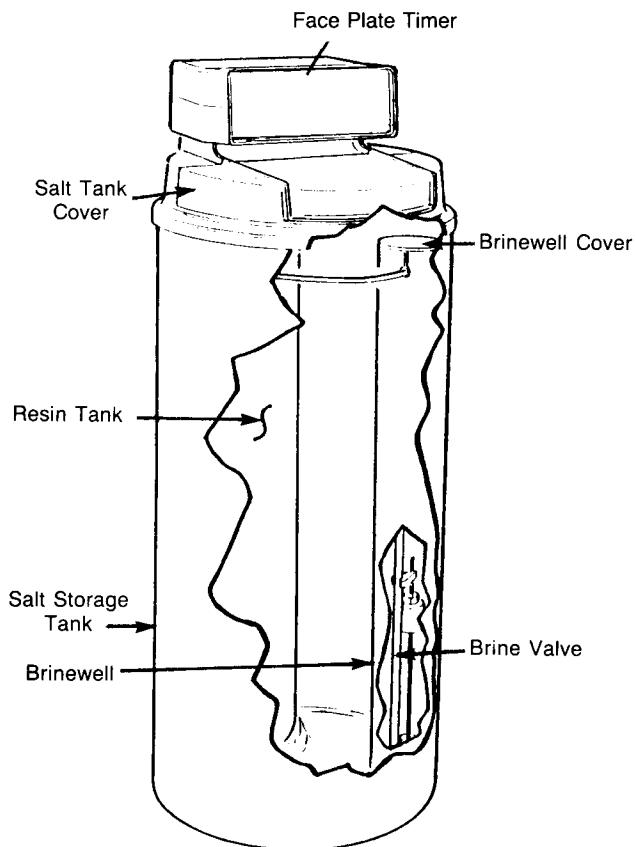

MODEL NOS. 625.3488003 and 625.348812

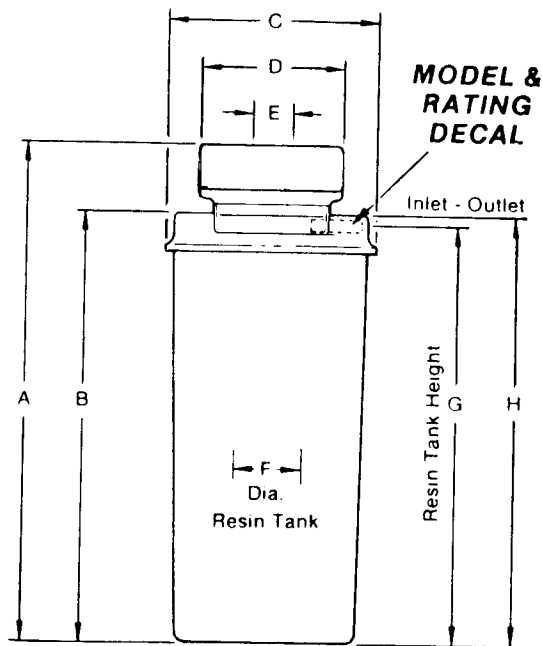

	INCHES	CENTIMETERS (Cm)
A	47-1/2	119.7
B	41-1/2	105.4
C	17-1/2	44.5
D	12-3/4	32.4
E*	3-3/8	8.6
F	8	20.3
G	40	101.6
H	41-1/2	105.4

*from center of inlet to center of outlet

SPECIFICATIONS

SOFTENER RATED CAPACITY (Grains @ Pounds of Salt)

MAXIMUM OPERATING LEVEL
MEDIUM OPERATING LEVELS

23,500 @ 6.8 (3.1 Kg)

19,500 @ 5.0 (2.3 Kg)

16,200 @ 3.5 (1.6 Kg)

14,300 @ 2.7 (1.2 Kg)

MINIMUM OPERATING LEVEL

SERVICE FLOW RATE (Gallons Per Minute) not over 15
pounds per square inch (psi) pressure loss

8.0 (30.3 liters)

REGENERATION FLOW RATES

FILL (Gallon Per Minute flow to Salt Storage Tank)

.10 (.38 liters)

BRINING

.16 (.6 liters)

BRINE RINSE } (Gallon Per Minute
BACKWASH } Flow to Drain)

.11 (.4 liters)

FAST RINSE

1.8 (6.8 liters)

1.8 (6.8 liters)

TYPE OF ION EXCHANGE MATERIAL (Resin)

High Capacity

AMOUNT OF RESIN (Cubic Feet)

.77 (.022 cu. m.)

TYPE OF SALT NEEDED

Nugget or Pellet

ALTERNATE TYPE OF SALT

Pure, evaporated, compacted
water softener salt

MAXIMUM WATER HARDNESS (Grains Per Gallon)

80

MAXIMUM "CLEAR WATER" IRON (Parts Per Million)

3.0

NOTE: The above flow rates obtained testing at 35psi inlet pressure.

SECTION 8

REPAIR PARTS . . . SEARS WATER SOFTENER

**MODEL NOS. 625.3488003
AND 625.348812**

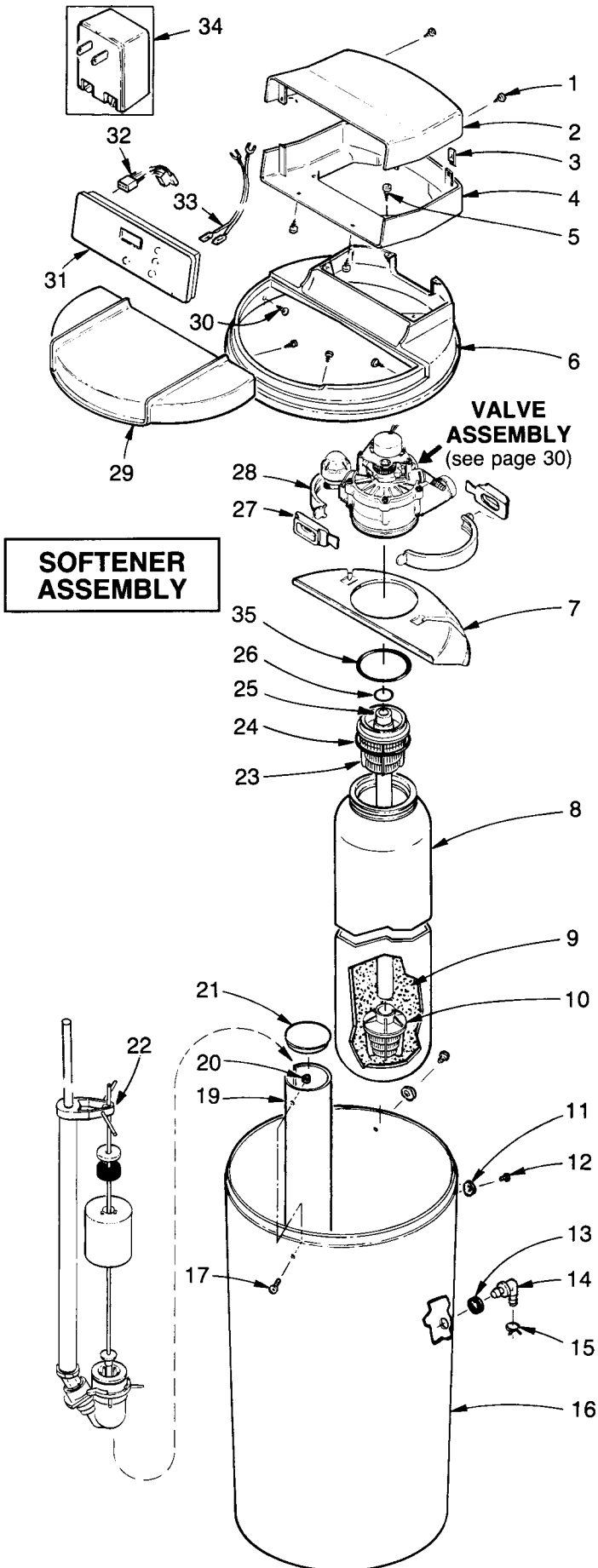

KEY NO.	PART NUMBER	DESCRIPTION
1	900562	Screw, #6 x 9/16 (4 req.)
2	7089568	Top Cover
3	900596	Speed Nut (4 req.)
4	7082605	Bottom Cover
5	7097812	Screw, #8-16 x 7/16 (4 req.)
6	7082590	Rim
7	7082891	Harness
8	7092155	Resin Tank (Incl. Key No. 9)
9	501744	Resin
10	7066497	Bottom Distributor
11	7119957	Washer (2 req.)
12	9006048	Screw, #.25-10 x 3/4 (2 req.)
13	9003500	Grommet ●
14	1103200	Hose Adaptor ●
15	900431	Hose Clamp ●
16	7112604	Salt Storage Tank
17	900712	Screw, #6-32 x 7/16
18	—	—
19	7100819	Brinewell
20	900706	Nut #6-32
21	500283	Brinewell Cover
22	7091353	Brine Valve Assembly
23	7077870	Top Distributor
24	7096183	O-Ring, 2-3/4 x 3
25	7105047	Repl. Distributor (Incl. Key No. 10)
26	900039	O-Ring, 1-1/16 x 1-1/4 (2 req.)
27	7088033	Clamp Retainer (2 req.)
28	7088041	Clamp Section (2 req.)
29	7092171	Cover, Salt Storage
◆	7089584	Decal, Cover
30	9006045	Screw, #6-18 x 5/8 (4 req.)
31	7122366	Face Plate (Timer)
32	7118333	Wire Harness (Switch)
33	7084330	Power Cord (Transformer)
34	7095373	Transformer, 24V-10VA ●
35	7079092	O-Ring, 2-7/8 x 3-1/4
◆	7117298	Owners Manual (F642-1392) ●

◆ not illustrated ● Included in small parts skin pack - see page 31

SECTION 8

REPAIR PARTS... SEARS WATER SOFTENER

MODEL NOS. 625.3488003 AND 625.348812

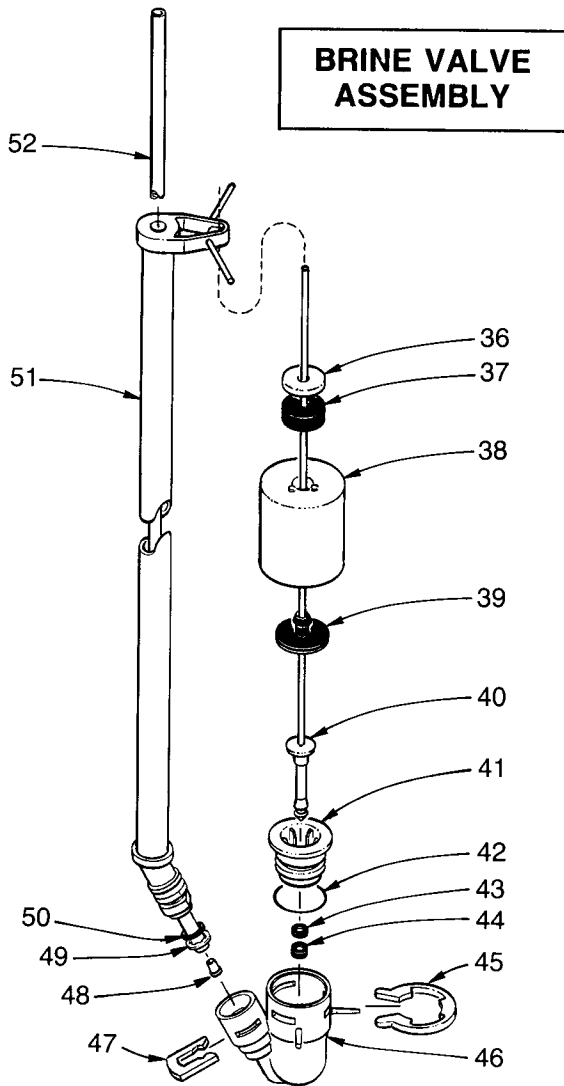

KEY NO.	PART NUMBER	DESCRIPTION
36	505957	Lead Washer
37	513860	Float Stop
38	7092317	Float
39	516947	Float Seal
40	7093216	Float Rod & Stem
41	7092278	Guide Cap
42	900535	O-Ring, 15/16 x 1-3/16
43	516211	Seal
44	516924	Retainer, Bottom Seal
45	7116713	Clip
46	7092252	Brine Valve Body
47	7080653	Clip
48	7094979	Insert
49	7092294	Retaining Ring
50	7092286	O-Ring, 5/16 x 9/16
51	7095470	Brine Tube
52	7089267	Tubing
53	7112997	Ground Clamp Kit ●

● parts included in small parts skin pack...see page 31.

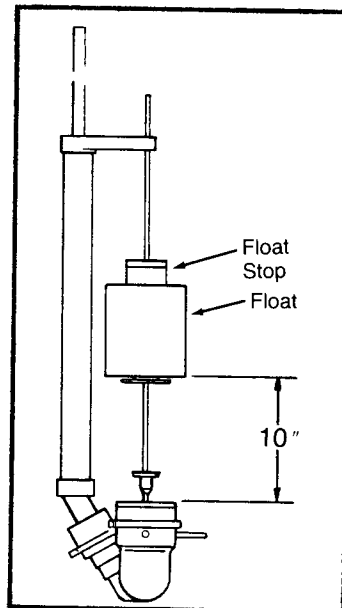
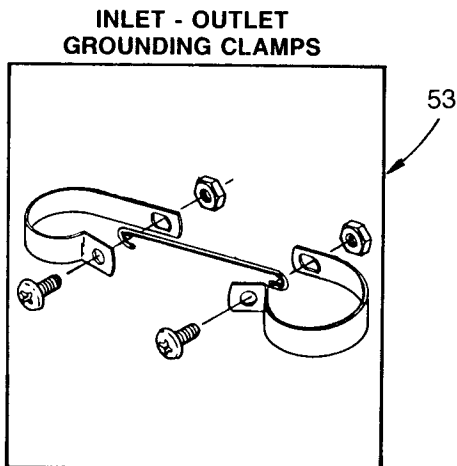

SECTION 8

REPAIR PARTS . . . SEARS WATER SOFTENER

MODEL NOS. 625.3488003
AND 625.348812

VALVE ASSEMBLY

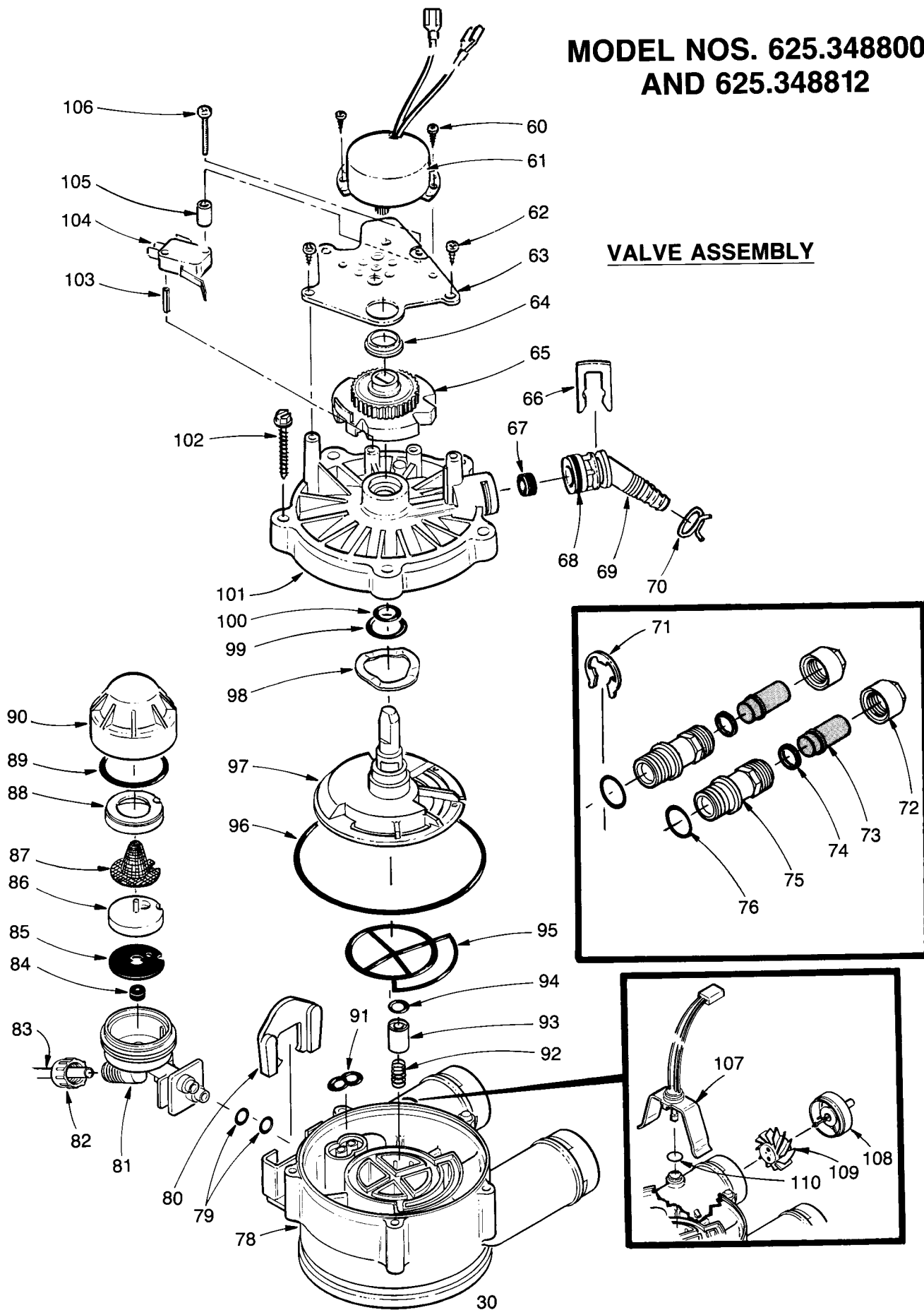

SECTION 8**REPAIR PARTS . . . SEARS WATER SOFTENER****MODEL NOS. 625.3488003
AND 625.348812****PARTS LIST**

KEY NO.	PART NUMBER	DESCRIPTION
60	900120	Screw, #6-18 x 3/8 (2 req.)
61	7070462	Motor
62	900857	Screw, #6-20 x 3/8 (2 req.)
63	7117808	Motor Plate
64	503288	Bearing
65	7113927	Cam and Gear
66	7080653	Clip (Drain)
67	501228	Flow Plug
68	900041	O-Ring, 5/8 x 13/16
69	7024160	Drain Hose Adaptor
70	900431	Hose Clamp ●
71	7116713	Clip (2 req.) ●
72	507369	Installation Nut (2 req.) ☐
73	507615	Installation Tube (2 req.) ☐
74	900570	Washer (2 req.) ☐
75	507371	Installation Adaptor (2 req.) ●
76	900535	O-Ring, 15/16 x 1-3/16 (2 req.) ●
77	—	—
78	7082053	Valve Body
79	900064	O-Ring, 1/4 x 3/8 (2 req.)
80	7081201	Retainer (Nozzle & Venturi)
81	7081104	Nozzle & Venturi Housing
82	1202600	Nut - Ferrule
83	7089267	Tubing
84	521829	Flow Plug, .1 gpm
85	7082582	Gasket
86	7085166	Nozzle and Venturi (Aspirator)
87	7090705	Screen
88	7089893	Screen Support

KEY NO.	PART NUMBER	DESCRIPTION
89	7039068	O-Ring, 3/8 x 1-3/8
90	7081188	Cap
91	7081764	Seal (Nozzle & Venturi)
92	1219600	Spring
93	7092642	Plug (Drain Seal)
94	7092634	O-Ring, 3/8 x 9/16
95	7081756	Rotor Seal
96	9001006	O-Ring, 3-3/8 x 3-5/8
97	7103964	Rotor & Disc
98	7082087	Wave Washer
99	7064372	O-Ring, 3/4 x 15/16
100	7064380	O-Ring, 7/16 x 5/8
101	7085263	Valve Cover
102	7074123	Screw, #10-14 x 2 (5 req.)
103	7077472	Expansion Pin
104	7030713	Switch
105	7117816	Spacer
106	7070412	Screw, #4-24 x 1-1/8 (flat head)
107	7097171	Sensor Housing
108	2204101	Turbine Support and Shaft
109	4020004	Turbine
110	9000803	O-Ring
◆	7085239	Nozzle & Venturi Assem. (Incl. Key Nos. 81, and 84 through 90)
◆	7117175	Small Parts Skin Pack. (Incl. all parts marked ●, pg. 28, 29, 31)
◆	7092163	Seal Kit (Incl. Key Nos. 91, 94, 95, 96, 99 and 100)

◆ not illustrated

☐ parts not included with softener – available from Sears, Stock No. 42-3441

SEARS

**OWNERS
MANUAL**

SERVICE

**MODEL NOS.
625.3488003
625.348812**

HOW TO ORDER
REPAIR PARTS

TELL SEARS YOU
WANT IT INSTALLED
THEN RELAX

Kenmore
Extra High Capacity 80
WATER SOFTENERS

Now that you have purchased your water softener, should a need ever exist for repair parts or service, simply contact any Sears Service Center. Be sure to provide all pertinent facts when you call or visit.

The model number of your water softener is found on the rating decal. This decal is on the inside, front of the storage tank rim.

WHEN ORDERING REPAIR PARTS, ALWAYS GIVE THE FOLLOWING INFORMATION:

- | | |
|----------------|--------------------|
| — PART NUMBER | — PART DESCRIPTION |
| — MODEL NUMBER | — NAME OF ITEM |

All parts listed may be ordered from any Sears Service Center.

If the parts you need are not stocked locally, your order will be electronically transmitted to a Sears Repair Parts Distribution center for handling.

When Sears arranges the installation, you can be sure the job is done right. We will arrange for professional workmanship . . . and we'll take care of the entire project. What's more, during installation you get insured protection . . . against property damage and also against accidents to workmen. All you have to do is talk to your Sears salesperson or call your nearest Sears store today for detailed information.

Sears, Roebuck and Co., Chicago, Ill. 60684 U.S.A.
